



Sorting Info

Guide to the new sorting label
for household packaging

APRIL 2022
New updated version



CITEO

Donnons ensemble une
nouvelle vie à nos produits.

01

Context

P. 03

02

Marketed in France

P. 10

How do I create Sorting Info that is adapted to my needs and constraints?

STEP 1 – Choosing the colour

STEP 2 – Choosing the Sorting Info design

- I. The Triman logo
- II. The Sorting Info block: choosing the call to action (with or without the strapline "Sorting made simpler")
- III. Choosing how to represent packaging components
- IV. Choosing how to represent the packaging waste stream
- V. Graphic standard elements to be used
- VI. Examples
- VII. Frequently asked questions

STEP 3 – Choosing the format

Special cases

03

Marketed in France and abroad

P. 32

How do I create Sorting Info that is adapted to my needs and constraints?

STEP 1 – Choosing the colour

STEP 2 – Choosing the Sorting Info design

- I. The Triman logo
- II. Tab labelled "FR"
- III. Choosing how to represent packaging components
- IV. Choosing how to represent the packaging waste stream
- V. Graphic standard elements to be used
- VI. Examples
- VII. Frequently asked questions

STEP 3 – Choosing the format

Special cases

01

Context

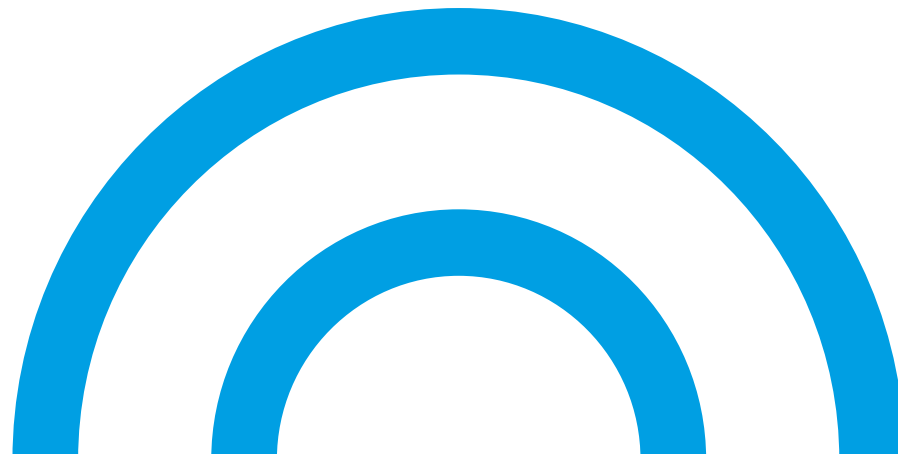

This guide provides all the information and guidelines you need to add the new mandatory harmonised sorting label to your household packaging. The aim is to provide your consumers with the information they need and ensure you are in compliance with the new regulatory requirements (Article 17 of the French AGEC Law and Decree no. 2021-835 of 29 June 2021).

Sorting and recycling are part and parcel of the challenge to consume more responsibly, with consumers increasingly engaging in the general effort. By adding Sorting Info to your packaging, you offer consumers reliable and now harmonised information to help them take action.

Sorting has become the number one environmental good deed of the French. Although 89% of French people sort their packaging waste, only 51% do it systematically⁽¹⁾. Sorting Info therefore serves to encourage people to sort more and make a habit of it. But it also helps them to adjust to the new, simpler process that now enables 35 million French people (over 52% of the population)⁽²⁾ to put all of their packaging into the sorting bin or container.

This new edition supplements the first edition of the Info Sorting Guide published in September 2021. We have added more details and information based on your feedback and new information provided by the public authorities. **Any updates made to the document are indicated using the following symbol:**



An English version of this guide is available in your secure Customer Space.

(1) Consumer sorting habits barometer – Citeo/IPSOS.

(2) Source: Citeo

What does the law say?

Article 17 of the French AGEC Law and its implementing decree (no. 2021-835 of 29 June 2021) establish the legal basis for consumer information regarding the sorting label.

Which are the most important points to remember?

- As soon as the sorting guidelines were extended to include over 50% of the French population (milestone met in January 2021), the sorting instructions on household packaging needed to be harmonised to inform consumers that all their packaging waste should be discarded in a sorting bin or container.
- This harmonised label providing sorting instructions (Sorting Info) will become mandatory from 1 January 2022. It will need to be accompanied by the Triman logo, whether the **packaging is recyclable or not** (see p. 11 or p. 33).
- The Sorting Info has been approved by the French Ministry for Ecological Transition and the French Ministry for the Economy and Finance, and is now the standard marking, easily recognised by consumers.
Consequently, all previous marking (standard or customised) will no longer be permitted from 9 March 2023.
- The legislation mentions a few exceptions: glass beverage bottles and any packaging smaller than 20 cm² in size may be exempted or subject to slightly different labelling obligations (see p. 30 or p. 52).

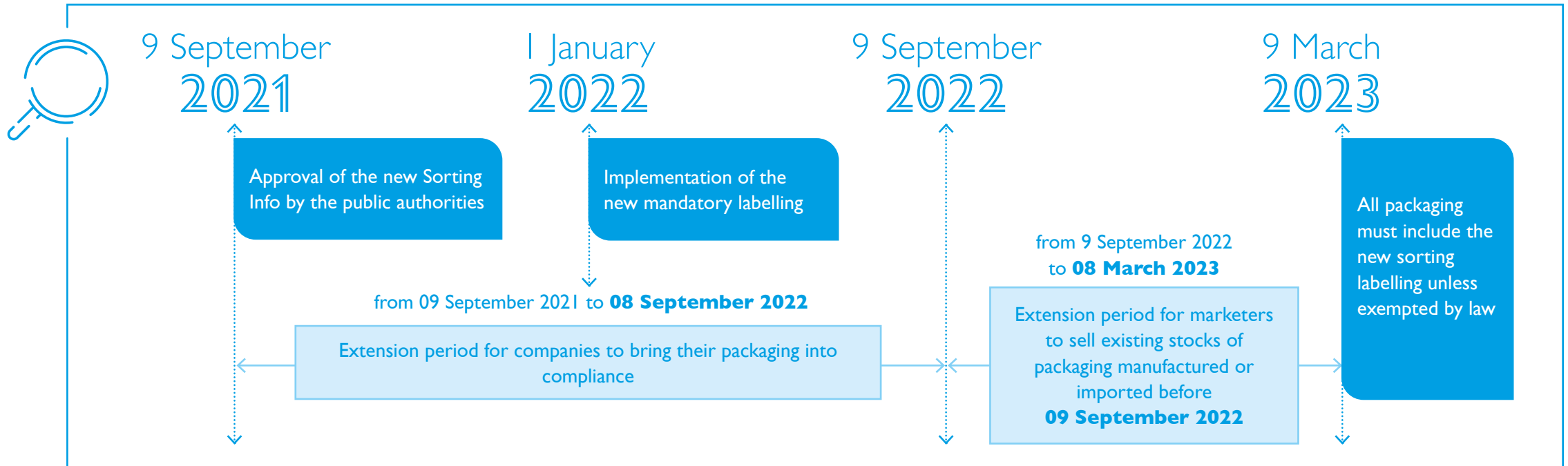



What about the other main EPR schemes?

Joint implementation for products covered by several EPR schemes.

The French Ministry for Ecological Transition announced an agreement in principle on the joint implementation of Sorting Info for products covered by the EPR scheme for household packaging as well as one or more other EPR schemes at the same time. This concession applies to EPR streams having submitted their final Sorting Info proposals before the end of 2021, along with those having obtained a specific agreement from the public authorities (to our knowledge: unused medicines, waste from healthcare activities posing risks of infections from sharps, and tobacco products).

Deadline for selling existing stock: packaging alone or packaged product?

Under the current legal framework, the marketing criterion only applies to packaged products. The Ministry for Ecological Transition has received several requests asking for more flexibility as regards packaging. The Ministry for Ecological Transition has therefore proposed to adjust the regulatory framework to enable the deadline for selling existing stock to also be applied to packaging that has been manufactured or imported before being used to package products. This decree is expected to be published in a few months.

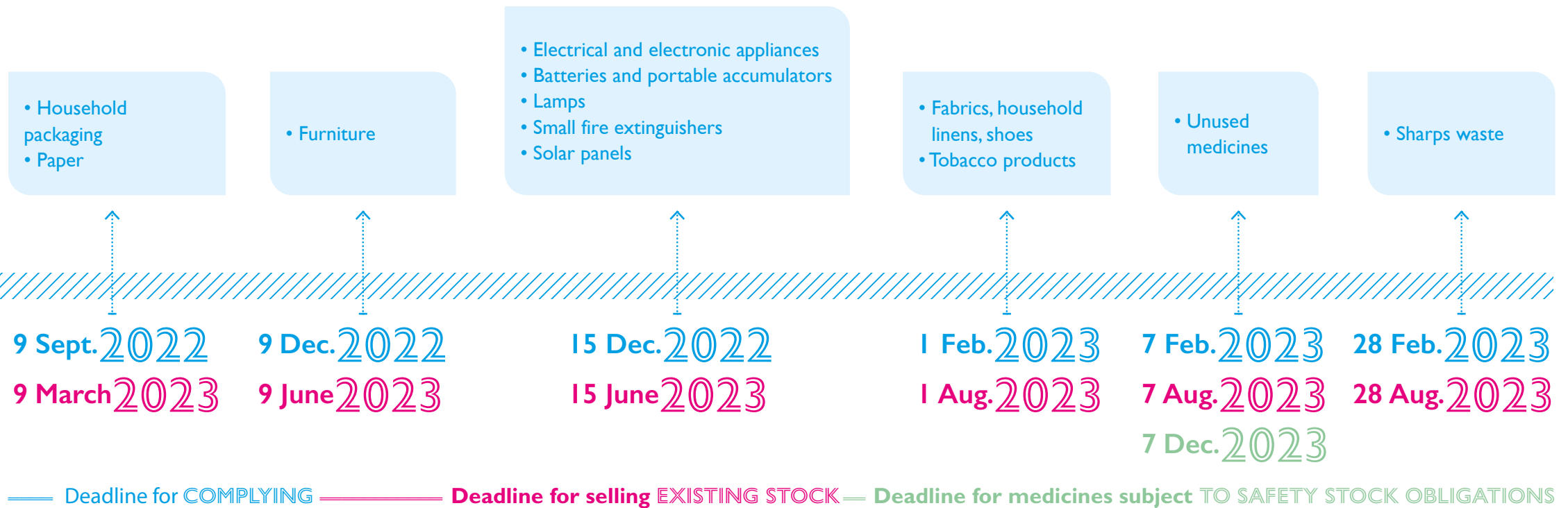

In practice, consumers expect simple and practical tools to help them sort their waste. Packaging is the first place they look for sorting information.

Sorting Info is:

- **mandatory from 1 January 2022.** It should appear on all household packaging, alongside the Triman logo, from that date onwards, with 9 March 2023 as the cut-off date.
- **governed by strict rules approved by the public authorities.** The label and the guidelines for its use have been approved by the French Ministry for Ecological Transition and the French Ministry for the Economy and Finance. They concern all companies placing household packaging on the market in France, **and can only be customised as indicated in the guidelines.**
- **adjustable.** Although governed by strict rules, the Sorting Info has nevertheless been designed to be adapted where possible to the needs and constraints of companies. It is available in different formats, sizes and colours.
- **tested and approved by consumers.** Like all marks previously developed by Citeo, the label has undergone three preliminary tests on representative samples of consumers (more than 3,000 people between July 2020 and June 2021), and proved to be very popular.



82%⁽¹⁾

of consumers found the Sorting Info useful

88%

say they trust this marking

75%

believe Sorting Info encourages the sorting of packaging



(1) Source: preliminary tests conducted on 1,250 shoppers under genuine purchasing conditions – Action Plus Shopper Research/Citeo (Phase 1 - Nov. 2020)



Citeo's objective: to support and guide you in creating your Sorting Info

We have taken care to combine **3 key aspects** to create the new Sorting Info:

- **Guaranteeing the regulatory compliance** of the label (compliance with the requirements of the French AGEC Law),
- **Ensuring the information is passed onto consumers effectively** (easy to understand, useful and incentive-based),
- **Making the label easy to implement** for your teams (advice and wide choice of options).

To help you make your choice, Citeo offers you advice based on our market knowledge and consumer feedback.

For example, we recommend you limit (or forgo) the use of text for export markets, to avoid having to translate it. However, we suggest you combine pictograms and text for the French market as consumers in France prefer this (the text serves to clarify uncertainties). Ultimately, **the final decision is yours to take, as long as you comply with the rules for using the label.**

*An English version is also available.

All the options presented have been approved by the public authorities, and tests on representative samples of consumers have shown how effective they are. Regardless of whether you market your products in France or abroad, you are free to **choose from these options** to create Sorting Info which is adapted to your company's packaging requirements and constraints.



le campus circulaire

You will find plenty of information on Citeo's circular campus platform to help you understand your needs and design the right Sorting Info:

- Module "On-pack communication: the new Sorting Info"*
- Module "Designing the Sorting Info label for France" *
- Module "Designing the Sorting Info label for export" *
- Replays of information session webinars (Oct. & Nov. 2021)
- FAQ containing over 200 questions and answers
- Ready-to-use Sorting Info Guide*

Sign up at: campuscirculaire.citeo.com

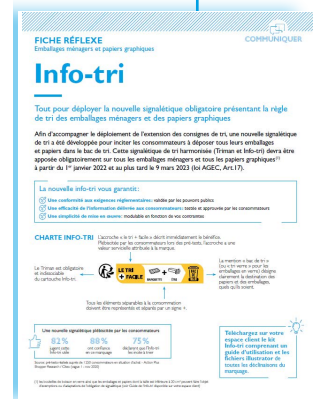

Which Sorting Info should I use on my packaging?

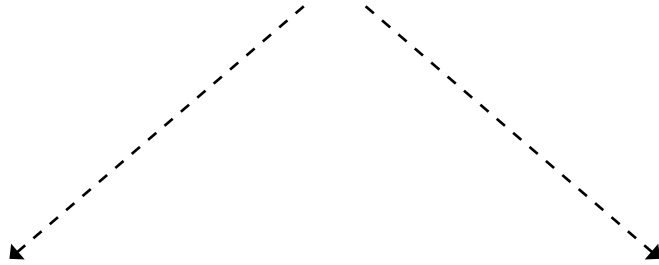

The packaging is solely intended for **the French market**

Go to page 10



The packaging is intended for several **markets (France/Abroad)**

Go to page 32

02



Marketed in France

How do I create Sorting Info that is adapted to my needs and constraints?

STEP 1 – Choosing the colour

STEP 2 – Choosing the Sorting Info design

- I. The Triman logo
- II. The Sorting Info block: choosing the call to action (with or without the strapline “Sorting made simpler”)
- III. Choosing how to represent packaging components
- IV. Choosing how to represent the packaging waste stream
- V. Graphic standard elements to be used
- VI. Examples
- VII. Frequently asked questions

STEP 3 – Choosing the format

Special cases



To support the extension of sorting instructions (ESI) effort, Sorting Info encourages French consumers to dispose of all their packaging waste in a sorting bin or container. Sorting becomes easier and the benefit for consumers is highlighted by the strapline “Sorting made simpler”.

The Triman logo is mandatory and may not be removed from the Sorting Info block (see p. 14).

All the packaging components that can be separated before consumption* must be shown, separated by a + sign. Components can be represented by pictograms and text, by pictograms alone, or text alone.



**LE TRI
+ FACILE**



+



BARQUETTE

ÉTUI



The term “Sorting bin” (or “Glass bank” for glass packaging) clearly indicates how different types of packaging should be discarded.

The strapline “Sorting made simpler” states the benefit immediately. Popular among consumers during preliminary tests, the strapline highlights the service value associated with the mark (see p. 15).

Séparez les éléments avant de trier

Optional extra information



The background colour of the “strapline” and “waste stream” areas corresponds to the colour of the sorting stream: green for glass packaging and yellow for other packaging.

Why use the term “Sorting bin” rather than “Recycle”?

Although most packaging can be recycled, some streams are not quite there yet. Consequently, some of the packaging that is sorted will not be recycled. It would therefore be misleading to claim that such packaging is recyclable.

Furthermore, now that there is a single, harmonised sorting rule, “Sorting bin” is the right term to use as all packaging waste must be disposed of there, regardless of recyclability.



How do I create Sorting Info that is adapted to my needs and constraints?

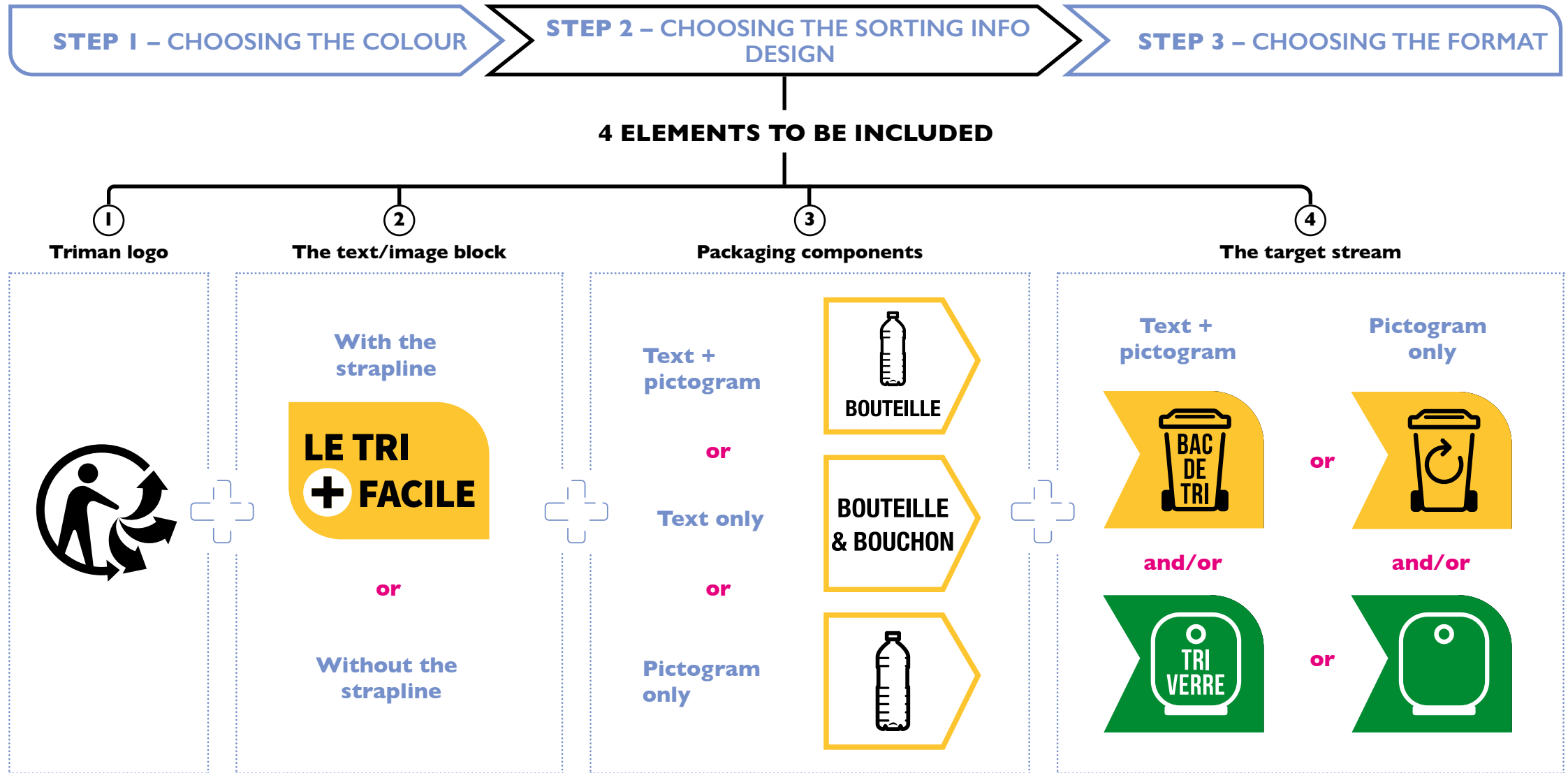

02 MARKETED IN FRANCE

STEP I – Choosing the colour

Colours



Monochrome of your choice



Good to know

You can use the pantone colour of your choice to make it easier to put the marking on your packaging. However, to ensure consumers clearly understand how to sort their waste, it is best not to use dark green, unless the Sorting applies to glass packaging, or yellow, unless the Sorting Info applies to lightweight packaging.

Label background

The choice of label options should always take legibility into account with regard to the background.

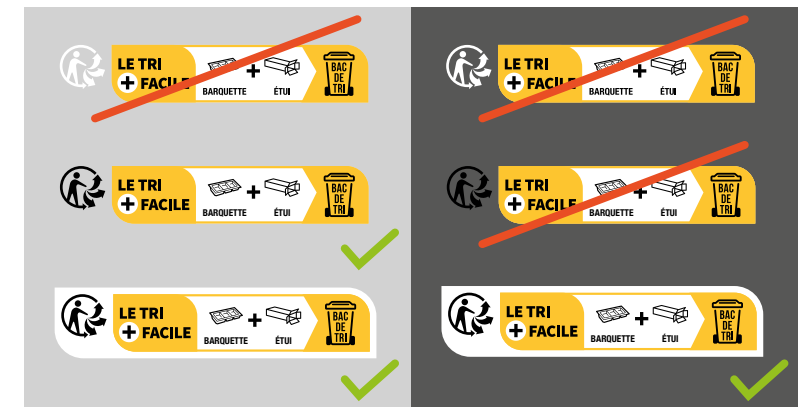

STEP 2 – Choosing the Sorting Info design

I. The Triman logo

The Triman logo is the symbol that informs the consumer that the product or packaging needs to be sorted or brought to a recycling point. In compliance with Article 17 of the AGEC Law, information on the sorting rule should also feature alongside the logo (in this case, Sorting Info for household packaging).

Specific information on size

In accordance with the original terms of use for the symbol, issued by Ademe⁽¹⁾, the Triman logo should not be smaller than a given minimum size:

Standard minimum size

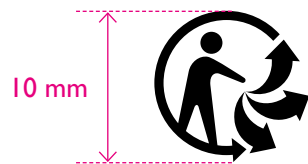

Compact minimum size

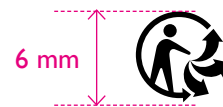

All the Sorting Info formats presented in this guide have been designed with these minimum-size requirements in mind.

Specific information on colours

If the Sorting Info design chosen includes colours, the Triman should always be black, unless **legibility** is an issue. If so, it should be used within its white box. If the Sorting Info is in monochrome, the Triman can be of the same colour as the Sorting Info as long as it remains legible, otherwise it should be in black.



When the Triman logo was created by Ademe in 2015, the aim was to inform the consumer that the product or packaging was recyclable and should be sorted accordingly. The logo was mandatory on recyclable packaging, or otherwise on the product instructions or other media (electronic included).

The French AGEC Law modified the meaning of the Triman logo and the rules for using it: the symbol became **mandatory on all packaging associated with a sorting or bring recycling rule, regardless of recyclability** (with the exception of a few cases mentioned on p. 30).

(1) <https://librairie.ademe.fr/dechets-economie-circulaire/2870-signalétique-commune-de-tri-triman-guide-d-utilisation.html>

STEP 2 – Choosing the Sorting Info design

II. The Sorting Info block: choosing the call to action (with or without the strapline “Sorting made simpler”)



“Sorting made simpler”: why is it important for the consumer?

This positive call to action highlights the reason why extending sorting instructions to all packaging is a major benefit to consumers: it makes sorting simpler. It is incentive-based and creates **service value** for the consumers surveyed, which they naturally associate with the trademarks.



**LE TRI
+ FACILE**

The strapline “Sorting made simpler” gives **1 out of 2 consumers** the impression that sorting has become easier.⁽¹⁾

(1) Source: Sorting Info preliminary tests – Action Plus Shopper Research / Citeo (2020-2021)

STEP 2 – Choosing the Sorting Info design

III. Choosing how to represent packaging components

Packaging can be represented in **one of three ways**

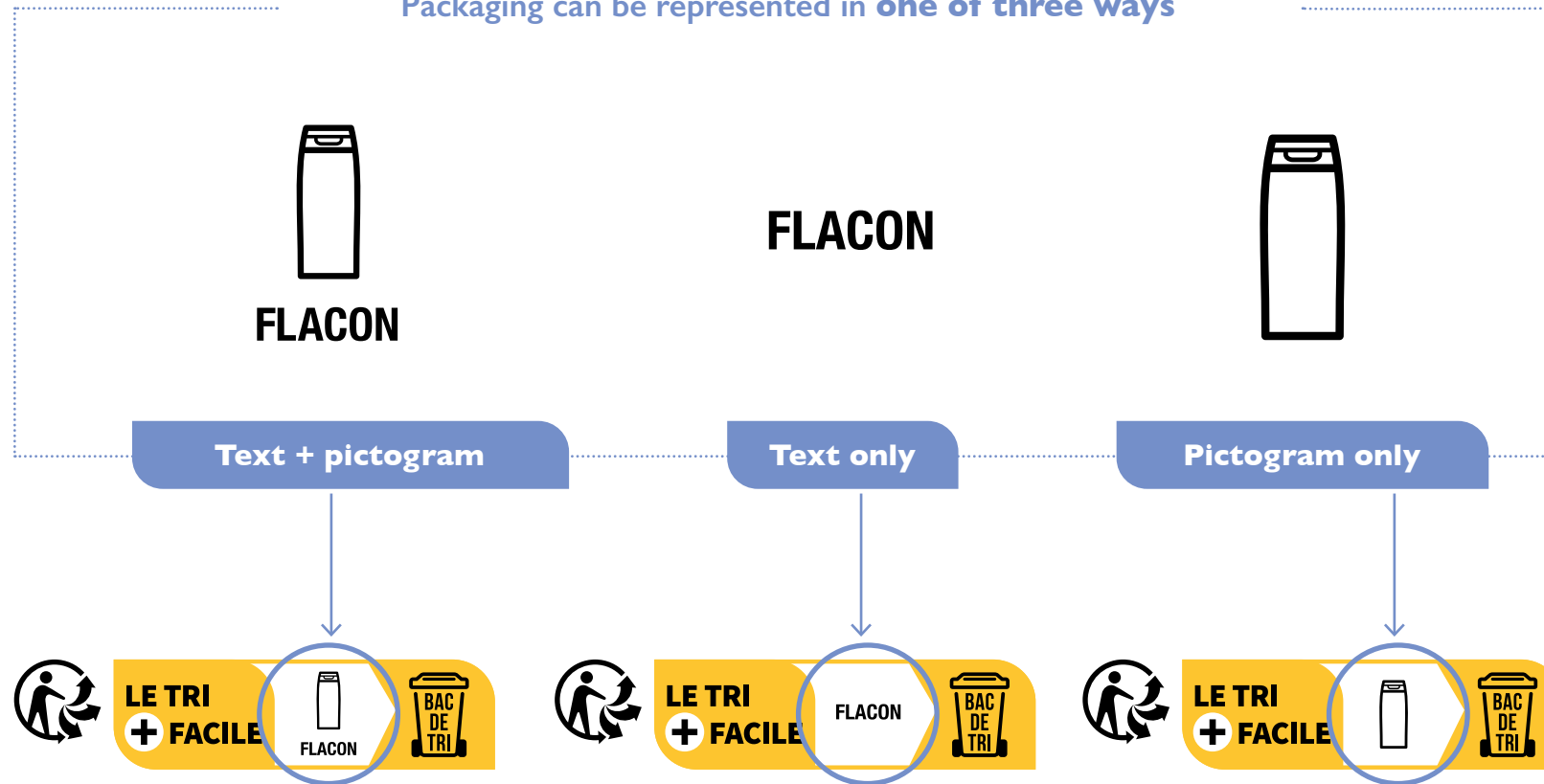

A "component" denotes any item of packaging that can be separated from the product when it is consumed or used. All components must be mentioned in the sorting information.

41% of consumers

believe that the wording which accompanies the pictograms helps to explain, reassure and avoid misunderstandings, especially for packaging that is difficult to represent as an image.⁽¹⁾

(1) Source: preliminary tests conducted on a representative sample of 1,280 consumers in ESI areas – Action Plus Shopper Research/Citeo (Phase 3 - June 2021)

STEP 2 – Choosing the Sorting Info design

IV. Choosing how to represent the packaging waste stream

The stream can be represented in **one of two ways**

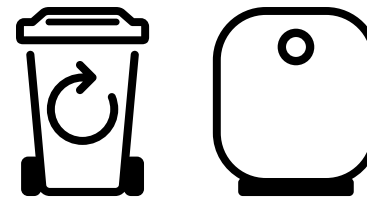
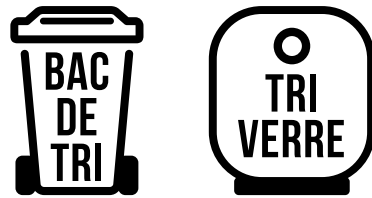

Text + pictogram

Pictogram only

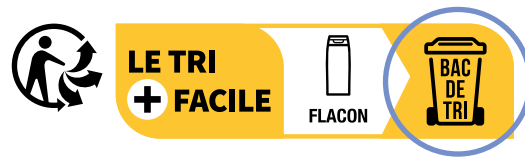

The drawings of the containers and the texts have been approved by the public authorities and may not be changed or customised.

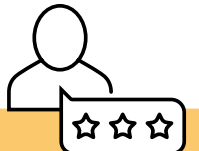

For products marketed in France only, Citeo recommends you use the pictogram and text combination. Considered clearer, it was the preferred option for **two-thirds of consumers** during preliminary tests⁽¹⁾.

(1) Source: preliminary tests conducted on a representative sample of 1,280 consumers in ESI areas – Action Plus Shopper Research/Citeo (Phase 3 - June 2021)

STEP 2 – Choosing the Sorting Info design

V. Graphic standard elements to be used

1. Triman logo ⁽¹⁾

All the Sorting Info logo formats presented are designed in keeping with the label's graphic standards issued by Ademe (see p. 14).

2. Typeface

2a Packaging components

Helvetica Neue 77 Bold Condensed in capital letters

2b Optional extra information

Helvetica Neue 67 Medium Condensed Oblique

3. Exclusion zone

The Sorting Info's exclusion zone should be three times the thickness of the border line. ^(3a) This zone must always be clear of any element that may affect the legibility of the sorting info. ^(3b) If the background is busy, this zone is represented by a white box: a legibility block.



Make sure that letter stems are always at least 0.2 mm thick.

Make sure that the body text size is always at least **5 pt**, regardless of the layout and format.

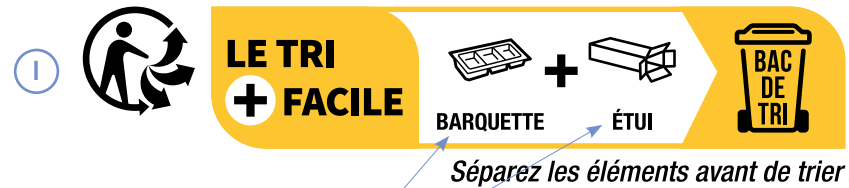

2a

Helvetica Neue 77 Bold Condensed
ABCDEFGHIJKLMNOPQRSTUVWXYZ

2b

Helvetica Neue 67 Medium Condensed Oblique
ABCDEFGHIJKLMNOPQRSTUVWXYZ
abcdefghijklmnopqrstuvwxyz

3a

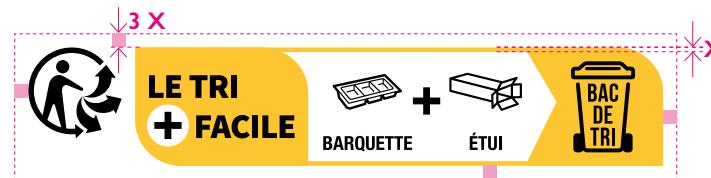

3b

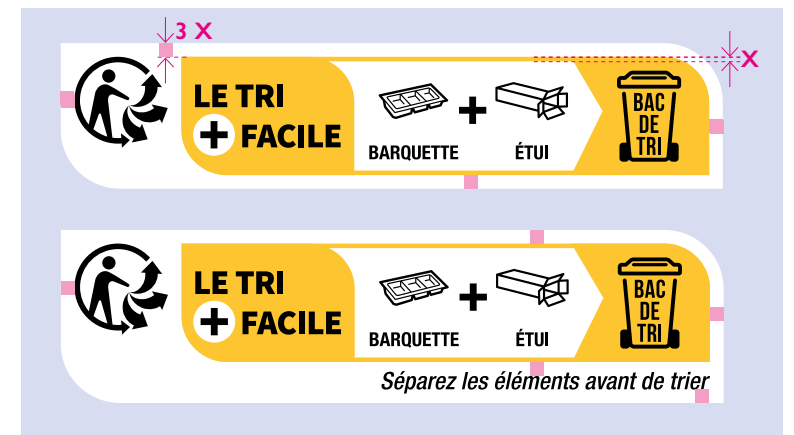
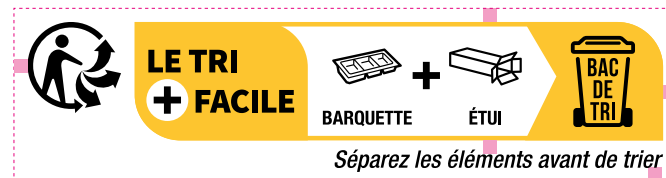

STEP 2 – Choosing the Sorting Info design

V. Graphic standard elements to be used

4. Packaging item pictograms

The pictograms available

A library of pictograms that depict most types of packaging currently in use (for food and non-food products) is available in your customer space.

Creating customised pictograms

You can design new packaging item outlines if necessary. In that case, you need to apply the following rules:

- the outline should preferably be a line drawing and only include two line thicknesses at most (a thicker line for the main contour and a thinner line for the internal details),
- the outline should be either (4a) a profile drawing or (4b) an isometric 3D drawing,
- the drawing must be able to fit into a 10 x 10 mm box, which in turn must be able to fit into a 13 x 13 mm box (default height of the standard Sorting Info block), with a clear space of 1.5 mm (see illustrations).

4a

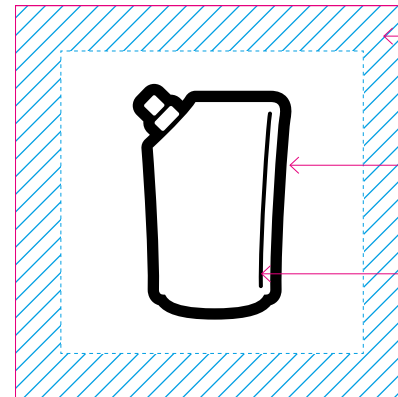
Examples of **profile** outlines

Clear space

Thick contour line

Thin internal line

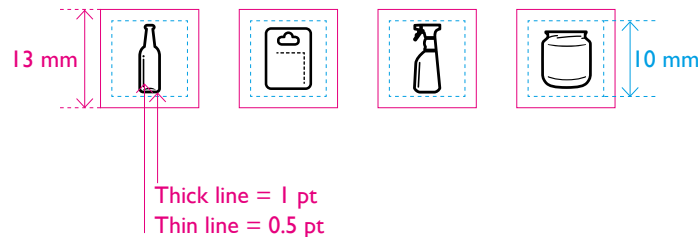

13 mm

10 mm

Thick line = 1 pt
Thin line = 0.5 pt

4b

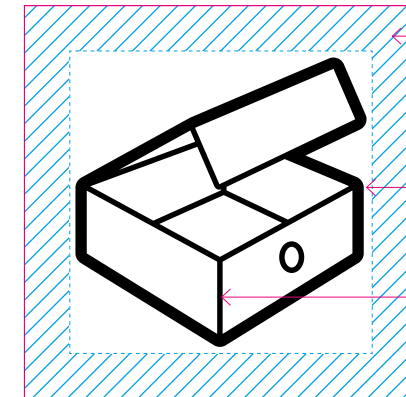
Examples of **isometric 3D** outlines

Clear space

Thick contour line

Thin internal line

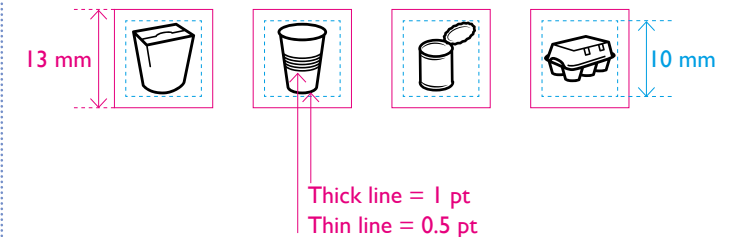

13 mm

10 mm

Thick line = 1 pt
Thin line = 0.5 pt

If you design new pictograms in compliance with the above instructions, they will not need to be approved by Citeo. Find the list of standard pictograms available per business sector, along with the corresponding graphics file, in your customer space (<https://clients-emballages.citeo.com>).

STEP 2 – Choosing the Sorting Info design

VI. Examples: cosmetic cream packaging

02 MARKETED IN FRANCE

Cosmetic cream packaging

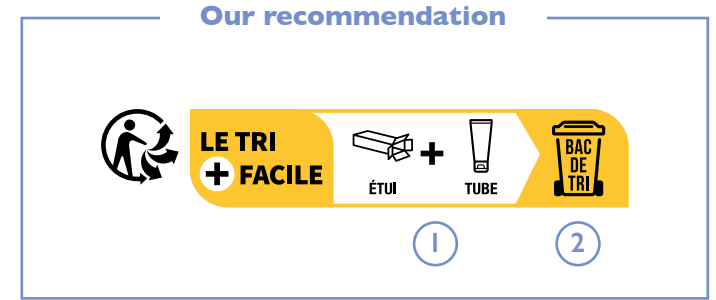
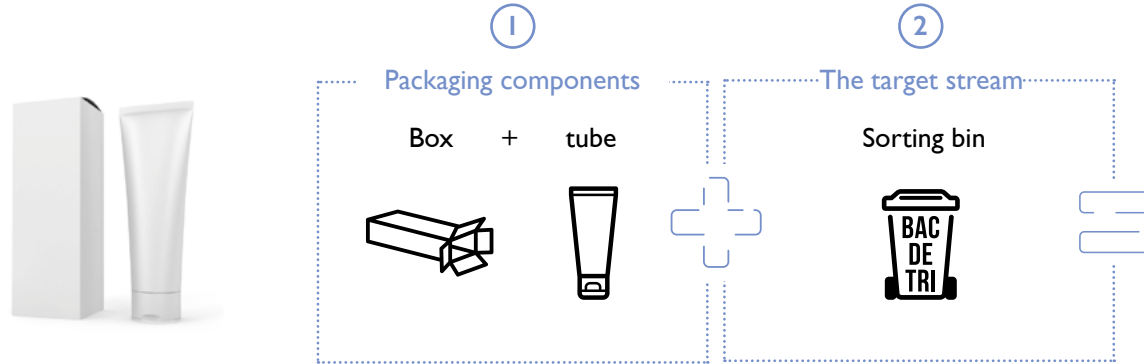

Other possibilities

With the strapline “Sorting made simpler”
and optional packaging separation information

Without the strapline
or optional extra information

- Text + pictogram
- Text only
- Pictogram only

Text + pictogram

Text only

Pictogram only

Without the strapline

Without the strapline

Without the strapline

If packaging includes 3 components or more, you are permitted to use the standard wording “packaging elements”.

All these versions are also available in monochrome.

STEP 2 – Choosing the Sorting Info design

VI. Example: beer bottle

Beer bottle

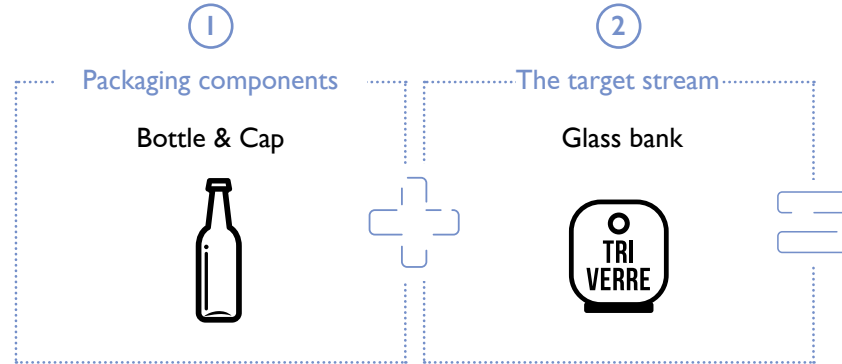

Other possibilities

With the strapline “Sorting made simpler”
and optional non-separation information

Without the strapline
or optional extra information

Text + pictogram	<p><i>Laisser la capsule sur la bouteille</i></p>
Text only	<p><i>Laisser la capsule sur la bouteille</i></p>
Pictogram only	<p><i>Laisser la capsule sur la bouteille</i></p>

Bottle tops, caps, lids:
which sorting rule applies and how can it be represented?
See p. 24.

All these versions are also available in monochrome.

STEP 2 – Choosing the Sorting Info design

VI. Example: jar



Other possibilities

	With the strapline “Sorting made simpler” and optional packaging separation information	Without the strapline or optional extra information
Text + pictogram	<p>LE TRI + FACILE COUVERCLE BAC DE TRI BOCAL TRI VERRE</p> <p><i>Séparez les éléments avant de trier</i></p>	<p>COUVERCLE BAC DE TRI BOCAL TRI VERRE</p>
Text only	<p>LE TRI + FACILE COUVERCLE BAC DE TRI BOCAL TRI VERRE</p> <p><i>Séparez les éléments avant de trier</i></p>	<p>COUVERCLE BAC DE TRI BOCAL TRI VERRE</p>
Pictogram only	<p>LE TRI + FACILE COUVERCLE BAC DE TRI BOCAL TRI VERRE</p> <p><i>Séparez les éléments avant de trier</i></p>	<p>COUVERCLE BAC DE TRI BOCAL TRI VERRE</p>

Bottle tops, caps, lids: which sorting rule applies and how can it be represented? See p. 24.

All these versions are also available in monochrome.

STEP 2 – Choosing the Sorting Info design

VII. Frequently asked questions (1/3)

Which guidelines apply if my packaging is made up of several components?

All the packaging components that can be separated during consumption must be shown, separated by a + sign.

Components can be represented by pictograms and text, by pictograms alone, or text alone. If packaging includes three components or more, you are permitted to use the standard phrase “packaging items”.

What is an element that can be “separated during consumption”?

This is an element that needs to be removed or separated from the main packaging to access the product (e.g. a cover or lid on a pot, a tube in a box, etc.). Packaging components that do not need to be removed for the product to be consumed (e.g. a pump or spray on a bottle, a sleeve on a bottle or pot, etc.) should not be mentioned in the Sorting Info, they are part of the main packaging element.

Why does this rule exist?

Asking consumers to systematically do more may prove counter-productive, especially with regard to consumers who only sort occasionally. This additional effort may also make consumers question how committed companies are to eco-design⁽¹⁾ principles.

What impact does it have on the evaluation of recyclability in the Citeo’s TREE tool?

Sorting Info does not have any direct impact on the evaluation of recyclability in TREE. The role of Sorting Info is to provide consumers with sorting instructions that encourage and help them to sort their waste. The role of TREE is to establish the recyclability of packaging based on data about actual sorting habits, which is collected at sorting centres. The method for calculating the recyclability indicator only takes packaging design into account, and not recommendations made to consumers.

Depending on the packaging, it may be advisable to **separate or not separate packaging components**, to make recycling easier. You also have the possibility of highlighting the need to separate or not separate certain packaging components, by adding **optional** extra information.

Optional separation information



Séparez les éléments avant de trier

Optional non-separation information



Laisser la capsule sur la bouteille

The wording of the extra information can vary according to the packaging components (e.g. “dispenser bottle” instead of “bottle” or “cap” instead of “bottle top”)⁽²⁾.

Aside from the cases described above, and in some special cases (see p. 31), the text in the block may not be modified to provide your consumers with extra information.

STEP 2 – Choosing the Sorting Info design

VII. Frequently asked questions (2/3)

Bottle tops, caps and lids: which sorting guideline applies and how can they be represented?

Bottle tops and caps

To ensure very small components are recovered and to prevent littering, bottle tops and caps should be left on all types of bottles and tubes. They now need to be represented on packaging (Example 1) or, if you are only using text, mentioned as part of the main packaging component by adding an “&” sign (Example 2).

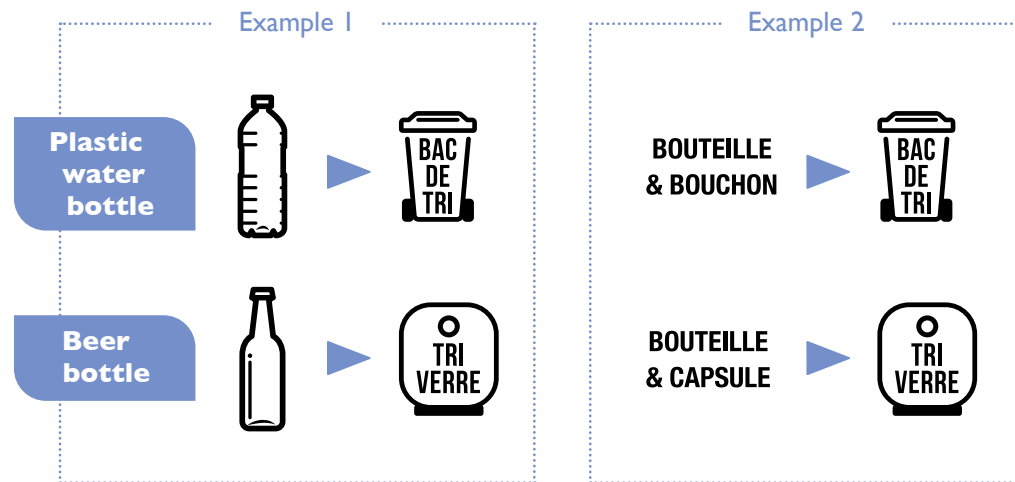

Flip top bottles - a special case

If you market bottles with flip tops attached to the bottle, you do not have to add the bottle top to the Sorting Info. You can just indicate “BOTTLE”. A pictogram of a bottle with a flip top attached is available in the Sorting Info kit’s pictogram library.

Lids

Larger than bottle tops and caps, lids can be identified at sorting centres. The separation instruction therefore varies **according to whether the lid is made of the same material as the main packaging or not**. If the material is the same, the lid can stay on the packaging (Example 3). If the material is different, the lid should be separated for sorting in the same place (Example 4), or in two different places (Example 5).

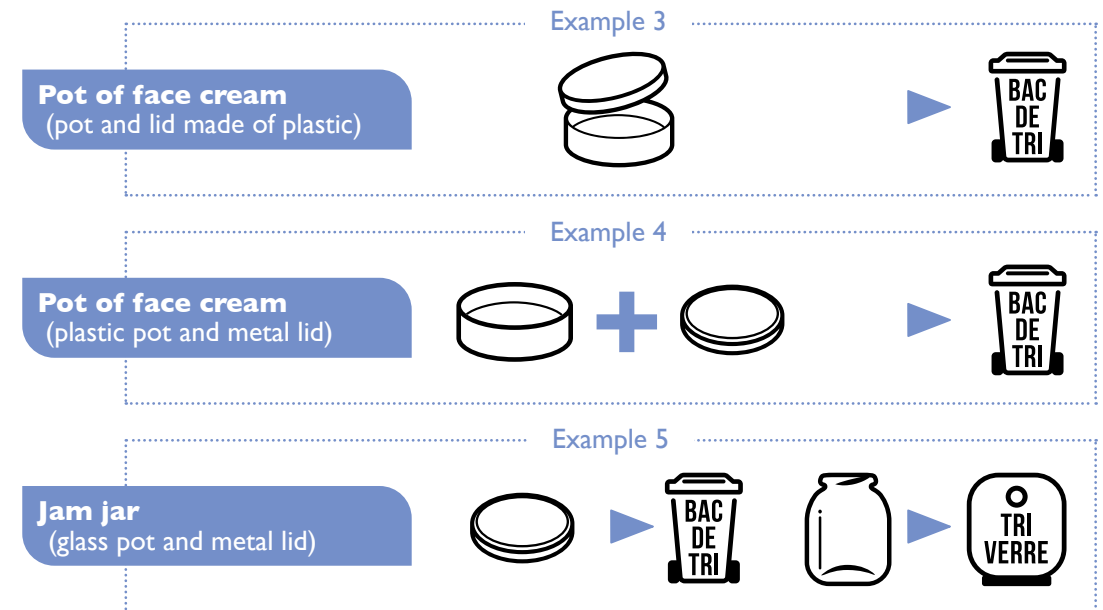

STEP 2 – Choosing the Sorting Info design

VII. Frequently asked questions (3/3)

Why use the terms “Sorting bin” and “Glass bank” rather than “Recycle”?

The term “Sorting bin” (or “Glass bank”) clearly indicates **the container in which the consumer now needs to dispose of their packaging waste, regardless of recyclability**.

It refers to the single, harmonised sorting rule defined by the French AGEC Law.

The above terminology was chosen over the term “Recycle” to ensure consumers would not be led astray as to the outcome of their packaging waste.

With the extension of sorting instructions, although most of the packaging waste discarded in the sorting bin can be recycled, some of it is still not recyclable.

It would be **misleading for the consumer** if “Recycle” was used on a universal label destined for all types of packaging as they would assume that all the packaging they sort is actually recycled.

Which pictograms can I use for my packaging?

A non-exhaustive library of standard pictograms is available to help you create your Sorting Info. If you cannot find a pictogram that represents your packaging item, you can create your own outline drawing to ensure your consumers understand the information provided as thoroughly as possible (see p. 19). If you apply the design instructions, the new pictograms do not need to be approved by Citeo.

“Sorting bin” and “Glass bank”



Reminder: the drawings of the containers and the texts have been approved by the public authorities and may not be changed or customised.

STEP 3 – Choosing the format

The Sorting Info format can vary according to the number of packaging components and any limits imposed by the packaging's shape or size.

We have a selection of **different layouts** to make it easier to incorporate Sorting Info onto your packaging.

Each one is available in **2 versions**:

- A Standard:** This is the main version: It should be used by default if there is sufficient space on the packaging, and can be enlarged.
- B Compact:** This version should only be used if space is limited. **It cannot be reduced in size** as the Triman logo used here is already set at the minimum height of 6 mm authorised by Ademe.



Find all the Sorting Info marks available, according to the desired layout or format, in your customer space (<https://clients-emballages.citeo.com>)

A Standard version



with the strapline "Sorting made simpler"

without the strapline

Horizontal



Vertical



Grouped

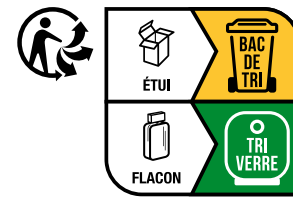
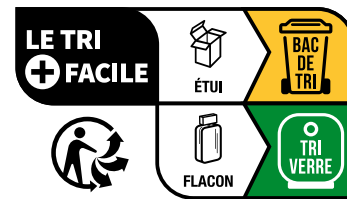

B Compact version



with the strapline "Sorting made simpler"

without the strapline

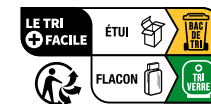

Please note: the Grouped version is only available for packaging destined for more than one recycling stream.

STEP 3 – Choosing the format

Horizontal layout with and without the strapline “Sorting made simpler”

A Standard: this is your go-to version. The height of the legibility block is 16 mm (19 mm with the optional extra information). The elements (pictograms and/or text) should fit into a 13 mm square box, as shown in the illustration opposite. This ratio must be kept for enlargements. In exceptional cases, the 13 mm space can be widened to accommodate long words and avoid word breaks. All the elements then need to be optically centred in the white space in the Sorting Info block.

B Compact: this version should only be used if space is limited. **It should never be reduced in size.** The height of the legibility block is 8 mm (10.8 mm with the optional extra information). The elements (pictograms and/or text) should fit into a 6.5 mm high rectangular box, as shown in the illustration. This ratio must be kept for enlargements. All the elements then need to be optically spaced and centred in the white space in the Sorting Info block.

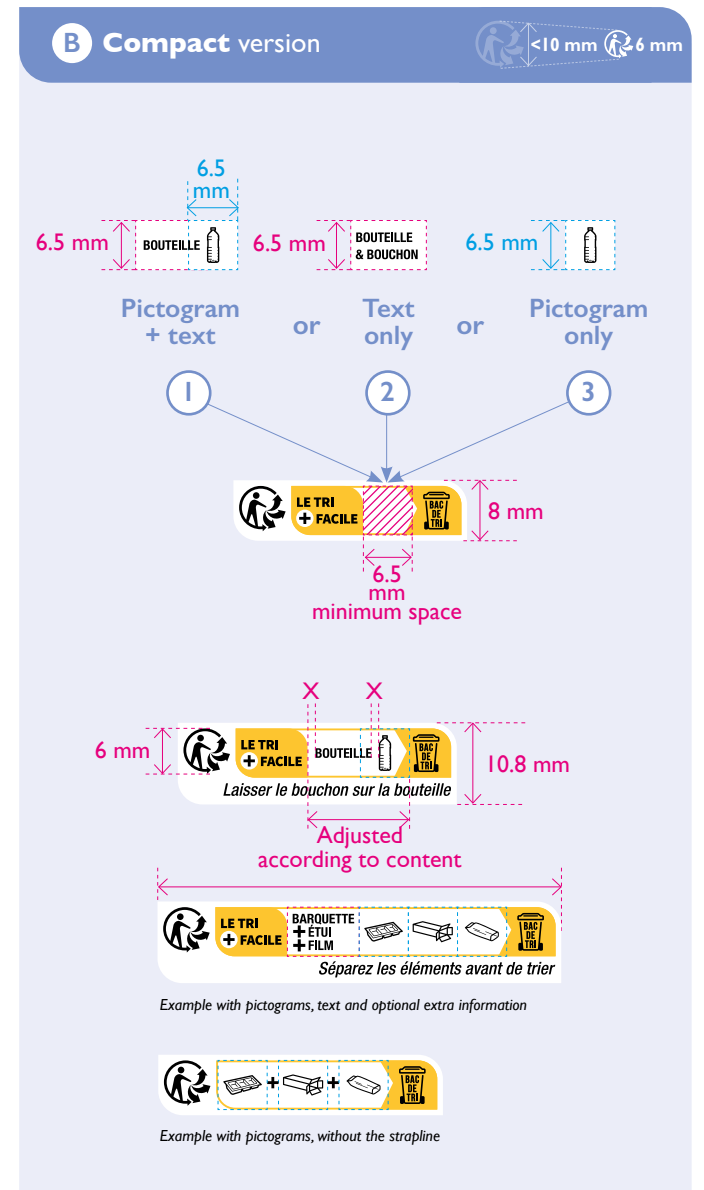
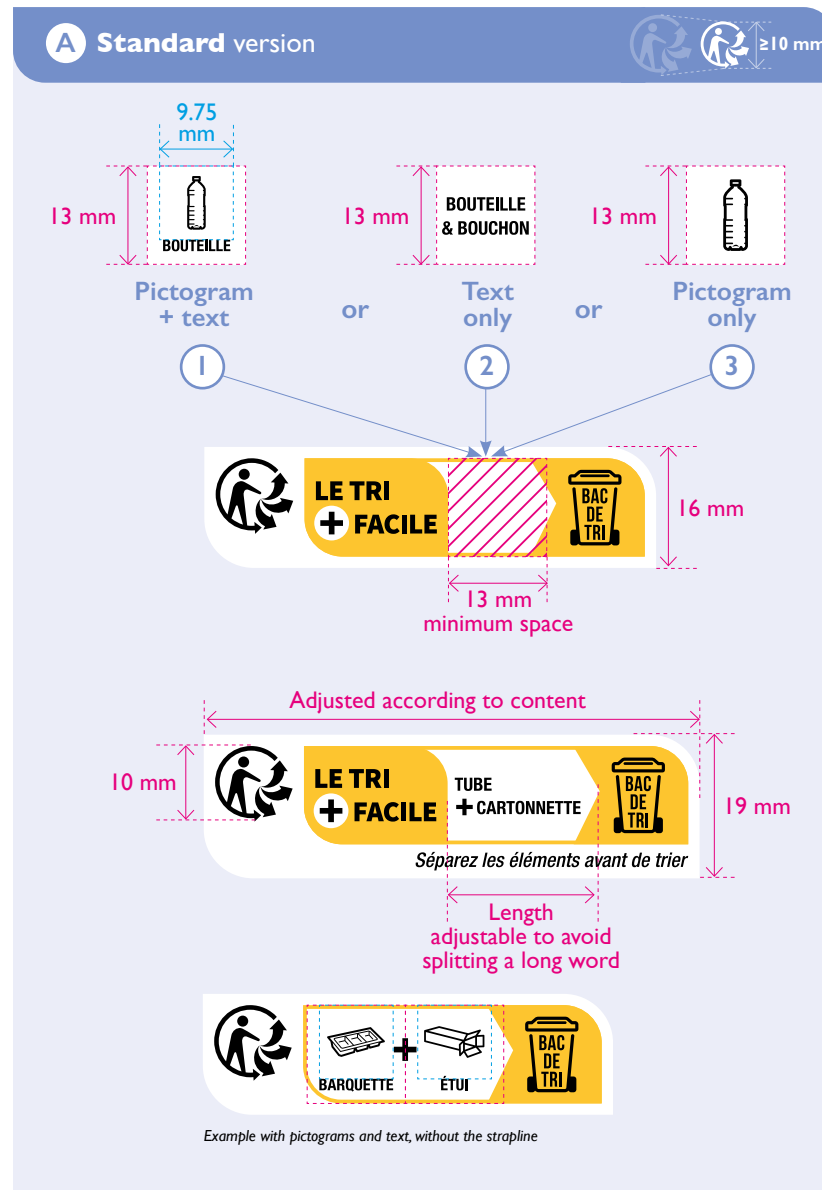

STEP 3 – Choosing the format

Vertical layout with and without the strapline “Sorting made simpler”

A Standard: this is your go-to version. The width of the legibility block is 22 mm (or 16 mm without the strapline) and the elements (pictograms and/or text) should fit into a 13 mm square box, as shown in the illustration opposite. This ratio must be kept for enlargements. All the elements then need to be optically centred in the white space in the Sorting Info block. If you add the optional extra information, the width of the legibility block will be 25 mm (19 mm without the strapline).

B Compact: this version should only be used if space is limited. **It should never be reduced in size.**

The width of the legibility block is 11 mm (or 8 mm without the strapline) and the elements (pictograms and/or text) should fit into a rectangular box, as shown in the illustration. This ratio must be kept for enlargements. All the elements then need to be optically centred in the white space in the Sorting Info block. If you add the optional extra information, the width of the legibility block will range from 13.8 to 15.7 mm (10.8 to 15.7 mm without the strapline).

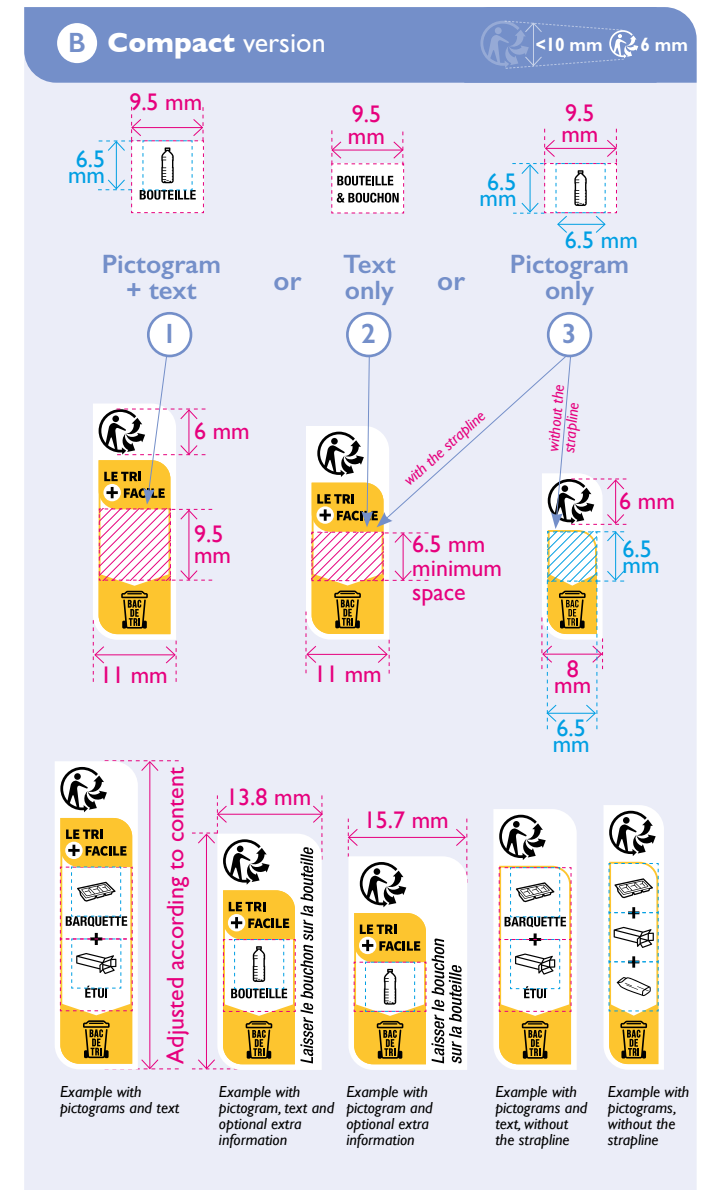
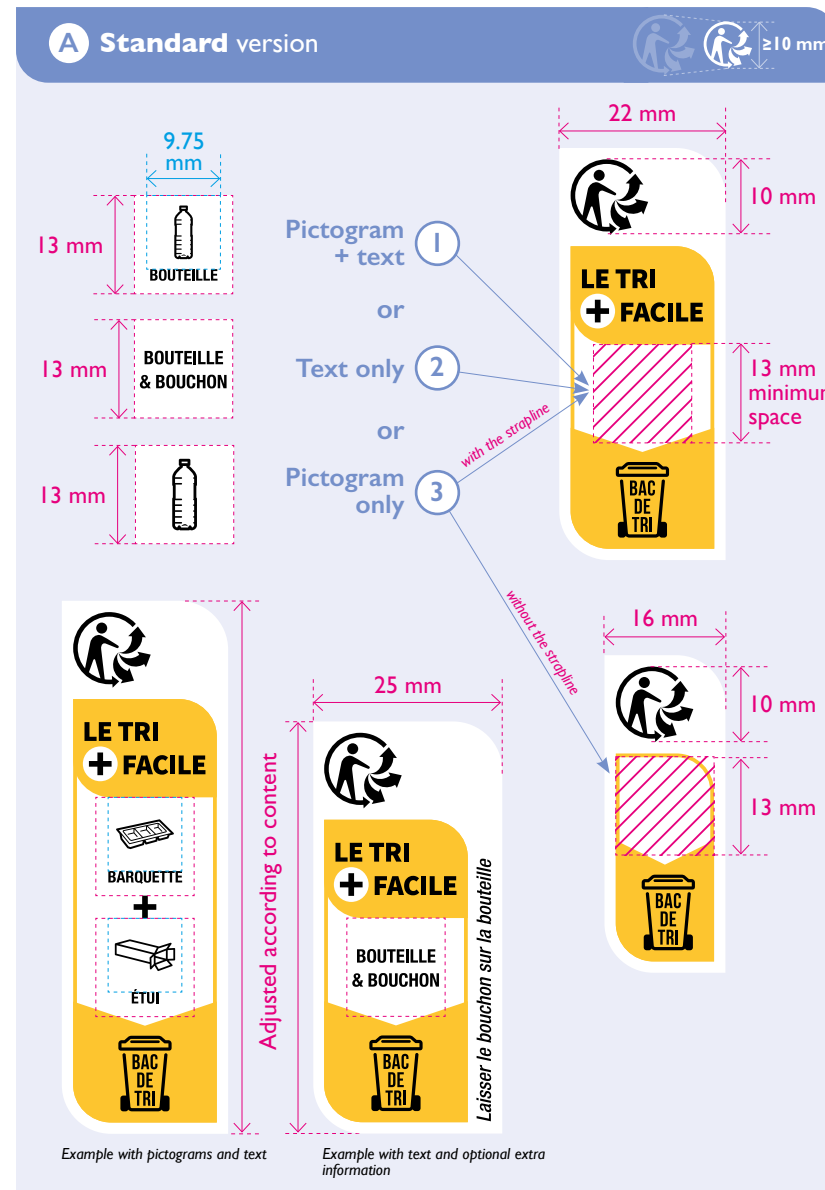

STEP 3 – Choosing the format

Grouped layout with and without the strapline “Sorting made simpler”

A Standard: this is your go-to version. The height of the legibility block is 28.5 mm (31.5 mm with the optional extra information). The elements (pictograms and/or text) should fit into a 13 mm square box, as shown in the illustration. This ratio must be kept for enlargements. In exceptional cases, the 13 mm space can be widened to accommodate long words and avoid word breaks. All the elements then need to be optically centred in the white space in the Sorting Info block.

B Compact: this version should only be used if space is limited. **It should never be reduced in size.**

The height of the legibility block is 14.25 mm (19.5 mm with the optional extra information). The elements (pictograms and/or text) should fit into a 6.5 mm high rectangular box, as shown in the illustration. This ratio must be kept for enlargements. All the elements then need to be optically spaced and centred in the white space in the Sorting Info block.

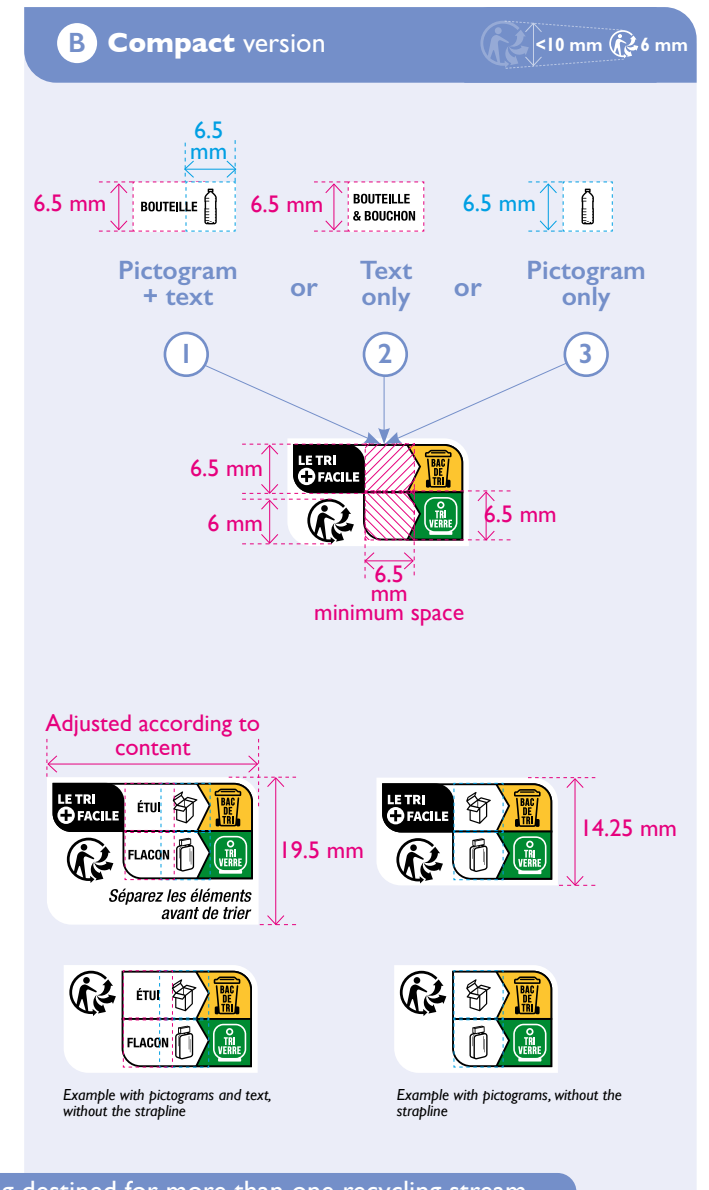
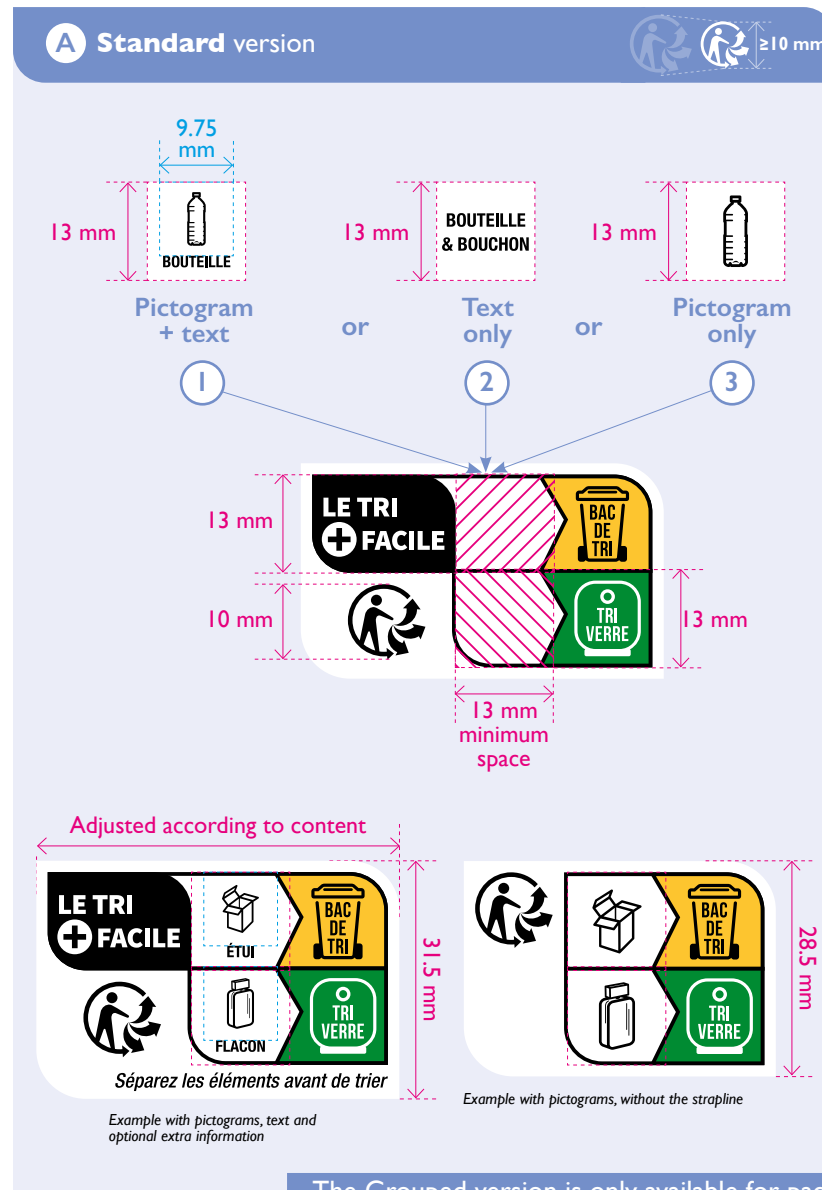

The Grouped version is only available for packaging destined for more than one recycling stream.



Special cases

Glass packaging for beverages

Article 17 of the French AGEC Law states that **glass packaging for beverages is exempt from the obligation** to add a sorting label. It is an exception. The Triman logo and Sorting Info are therefore added on glass beverage bottles on a voluntary basis.



Caution: if your glass packaging for beverages carries a previous version of the Sorting Info label, you are free to replace it with the new label or remove it completely. **In both cases, you will need to change the design on your packaging as you will no longer be able to use the former Sorting Info label from 9 March 2023.**

Small packaging items

The implementing decree of Article 17 of the AGEC Law sets out specific provisions for two types of small packaging item:

- 1 **Packaging items less than 10 cm² in size** (largest side or total surface area) without accompanying documentation are exempt from sorting label and on-pack information obligations provided that corresponding information is available in electronic format.
- 2 **Packaging items between 10 and 20 cm² in size** (largest side or total surface area) without accompanying documentation must carry the Triman logo but are exempt from on-pack information obligations provided that such information is available in electronic format.

Small cylindrical or spherical packaging

For this type of packaging, a future decree will modify the above-mentioned 10 and 20 cm² surface areas to 20 and 40 cm² respectively. Please note, however, that this decree was not yet published in April 2022, when this document was updated. The new rules may not be adopted until the decree confirming this special case has been published officially.



79%⁽¹⁾

of consumers believe it is important to have sorting instructions on packaging.

64%⁽¹⁾

also believe the guideline would encourage them to choose one off-the-shelf product over another.

Special cases

Compostable packaging

No collection and industrial processing system for compostable packaging waste currently exists at a national level in France. This type of packaging is processed within the French national household packaging waste sorting and recycling system.

Therefore, regardless of whether this type of packaging is home or industrially compostable, it **has to feature the Sorting Info label**.



Please note: Article 13 of the AGEC Law stipulates that **only home-compostable packaging** can use the word “compostable”. The text “**également compostable à domicile, ne pas jeter dans la nature***” can therefore also be added as extra information under the Sorting Info block.

Examples



*Également compostable à domicile,
ne pas jeter dans la nature*



*Également compostable à domicile,
ne pas jeter dans la nature*



Important: if only one or part of a packaging component is compostable, this must be clearly stated.



Étui également compostable à domicile, ne pas jeter dans la nature

Aside from the optional wording described on p. 24, and in some special cases, the text in the block may not be modified to provide your consumers with extra information.

03

Marketed in France and abroad



How do I create Sorting Info that is adapted to my needs and constraints?

STEP 1 – Choosing the colour

STEP 2 – Choosing the Sorting Info design

- I. The Triman logo
- II. Tab labelled “FR”
- III. Choosing how to represent packaging components
- IV. Choosing how to represent the packaging waste stream
- V. Graphic standard elements to be used
- VI. Examples
- VII. Frequently asked questions

STEP 3 – Choosing the format

Special cases

To support the extension of sorting instructions (ESI) effort, the Sorting Info label encourages French consumers to dispose of all their packaging waste in a sorting bin. The version presented in this section has been designed for products marketed both in France and abroad, with multilingual packaging. The purpose is to give information about the sorting instructions applicable in France in such a way that they can also be understood by consumers in another country.

The abbreviation “FR” is mandatory if the product is sold outside of France. It serves to clearly indicate that the sorting rule applies to French territory (see p. 37)

All the packaging components that can be separated before consumption* must be shown, separated by a + sign. Components can be represented by pictograms and text, by pictograms alone, or text alone.

The Triman logo is mandatory and may not be removed from the Sorting Info block (see p. 36).

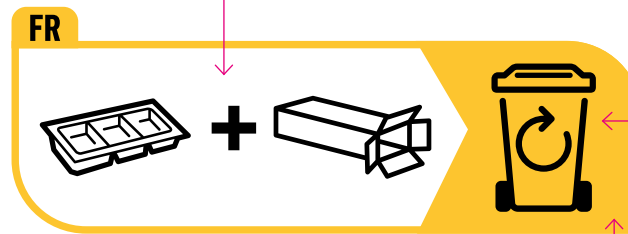

The sorting bin pictogram (or glass bank pictogram) clearly indicates how different types of packaging should be discarded.



The contours of the Sorting Info block and background of the “target stream” area correspond to the colour of the sorting stream: green for glass packaging and yellow for other packaging.

Why use a circular arrow on the bin rather than the Möbius loop (recyclability symbol)?

Although most packaging can be recycled, some streams are not quite there yet. Some of the packaging that is sorted as part of the ESI cannot be recycled. Hence, it would be misleading for consumers if the Möbius loop featured on the sorting bin, which is to be used to discard all types of packaging, regardless of recyclability. It was therefore felt that a circular arrow would better represent the purpose of the sorting bin. The symbol is understood by 7 out of 10 consumers⁽¹⁾.



(1) Source: preliminary tests conducted on a representative sample of 1,280 consumers in ESI areas – Action Plus Shopper Research/Citeo (Phase 3 - June 2021) *For more information on separability, go to p. 45

How do I create Sorting Info that is adapted to my needs and constraints?

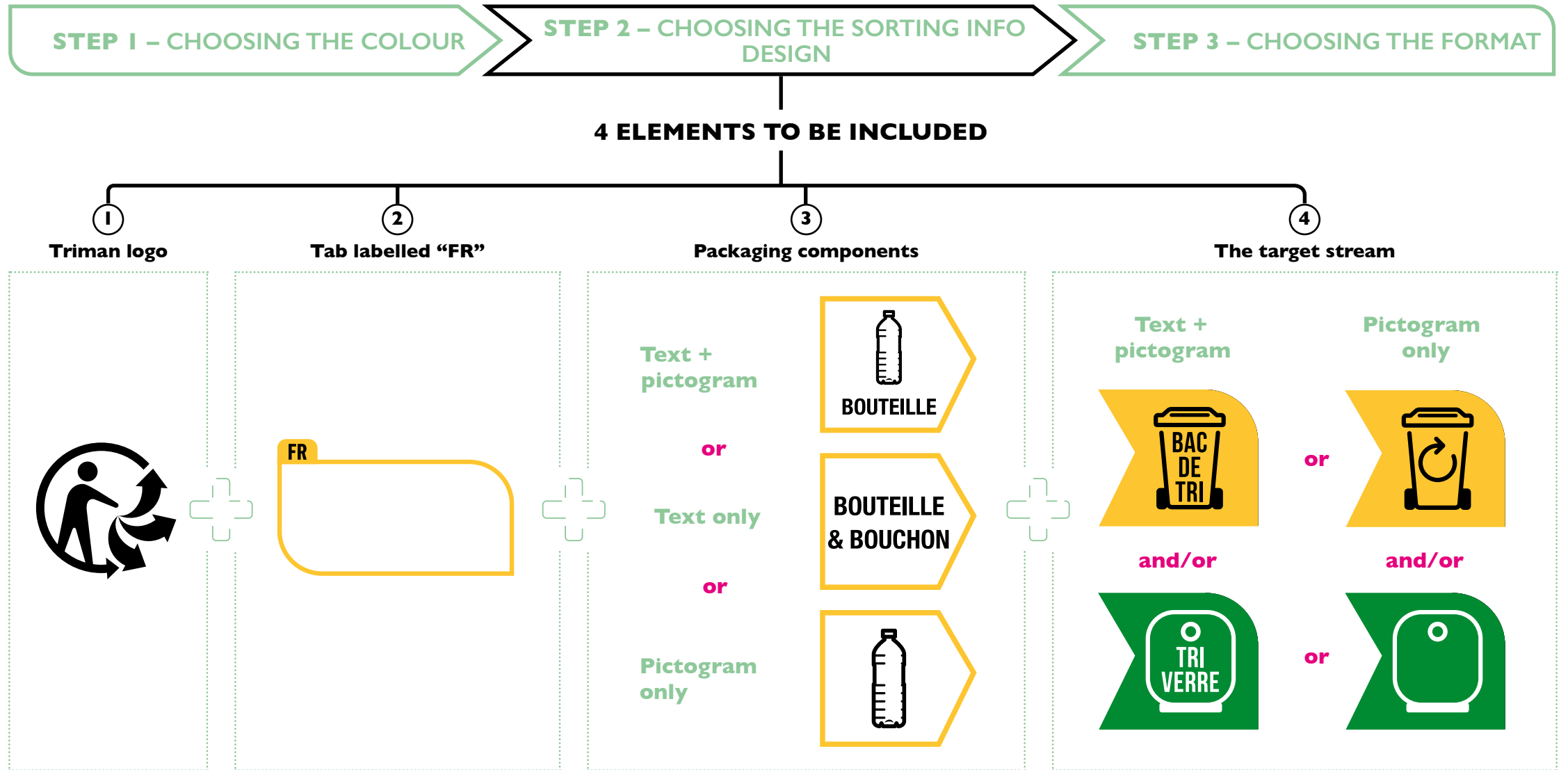

STEP I – Choosing the colour

Colours

Glass packaging



Monochrome of your choice

Non-glass packaging

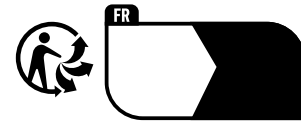
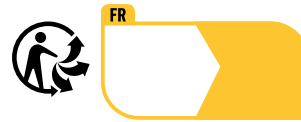

Non-glass + glass packaging

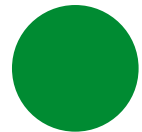
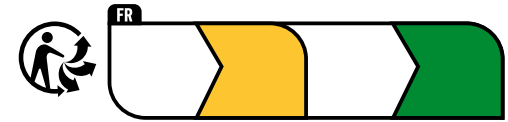

Pantone 2258 C
C85 M0 J100 N20



Pantone 123 C
C0 M25 J86 N0

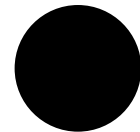

Pantone Black C
C0 M0 J0 N100

Good to know

You can use the pantone colour of your choice to make it easier to put the marking on your packaging. However, to ensure consumers clearly understand how to sort their waste, it is best not to use dark green, unless the Sorting applies to glass packaging, or yellow, unless the Sorting Info applies to lightweight packaging.

Label background

The choice of label options should always take legibility into account with regard to the background.

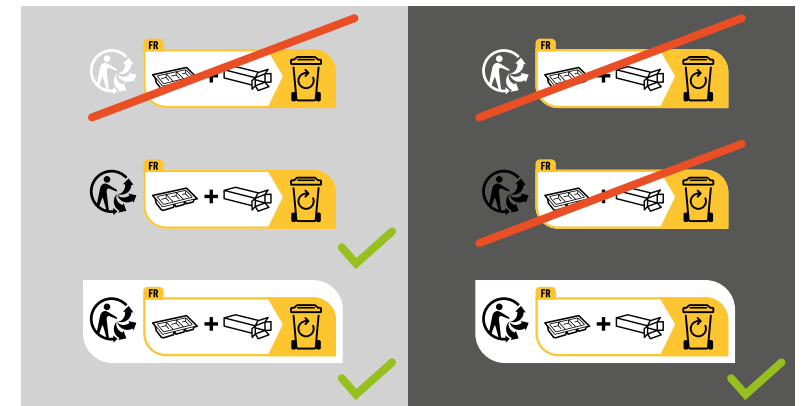

STEP 2 – Choosing the Sorting Info design

I. The Triman logo

The Triman logo is the symbol that informs the consumer that the product or packaging needs to be sorted or brought to a recycling point. In compliance with Article 17 of the AGEC Law, information on the sorting rule should also feature alongside the logo (in this case, Sorting Info for household packaging).

Specific information on size

In accordance with the original terms of use for the symbol, issued by Ademe⁽¹⁾, the Triman logo should not be smaller than a given minimum size:

Standard minimum size

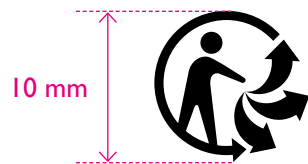

Compact minimum size



All the Sorting Info formats presented in this guide have been designed with these minimum-size requirements in mind.

Specific information on colours

If the Sorting Info design chosen includes colours, the Triman should always be black, unless **legibility** is an issue. If so, it should be used within its white box. If the Sorting Info is in monochrome, the Triman can be of the same colour as the Sorting Info as long as it remains legible, otherwise it should be in black.



When the Triman logo was created by Ademe in 2015, the aim was to inform the consumer that the product or packaging was recyclable and should be sorted accordingly. The logo was mandatory on recyclable packaging, or otherwise on the product instructions or other media (electronic included).

The French AGEC Law modified the meaning of the Triman logo and the rules for using it: the symbol became **mandatory on all packaging associated with a sorting or bring recycling rule, regardless of recyclability** (with the exception of a few cases mentioned on p. 52).

(1) <https://bibrairie.ademe.fr/dechets-economie-circulaire/2870-siglaetique-commune-de-tri-triman-guide-d-utilisation.html>

STEP 2 – Choosing the Sorting Info design

II. Tab labelled “FR”

Please note that the Sorting Info label is governed by French law. Its purpose is to inform the consumer of the packaging sorting rules **applicable to France’s national territory** (mainland France and its overseas territories).

① That is why the Sorting Info block on products marketed both in France and abroad has to include a tab labelled “FR”, to inform all the consumers who may buy the product that the rule applies to France only.

② However, if the packaging sorting rule is the same across several countries in which the product is marketed, other country code tabs can be added alongside the “FR” tab for the countries concerned.

Where ② is concerned, **colours other than black and white are prohibited** as the colour coding for sorting streams may vary from one country to another (read more about international Sorting Info on p. 53).

①

Examples featuring the “FR” tab

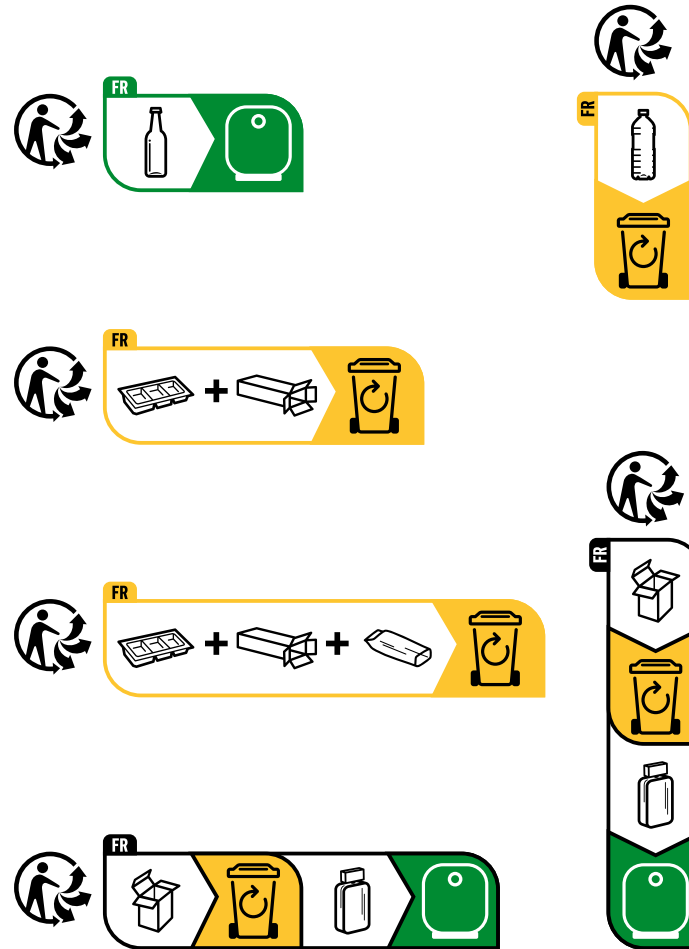

②

Examples for a sorting rule that is applicable both in France and in other countries

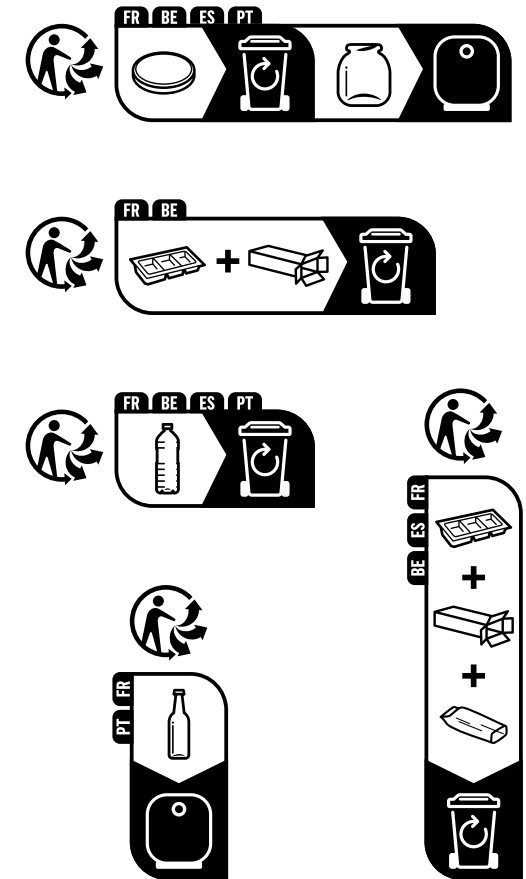

Please note: the sorting instructions shown in this Sorting Info block are not real-life examples.

STEP 2 – Choosing the Sorting Info design

III. Choosing how to represent packaging components

Packaging can be represented in **one of three ways**

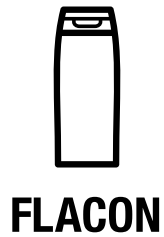

FLACON



Text + pictogram

Text only

Pictogram only

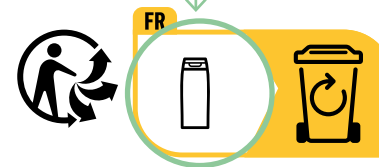
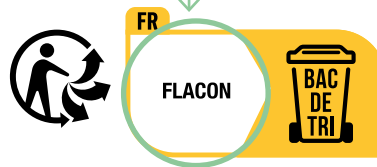
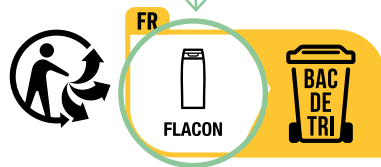

A "component" denotes any item of packaging that can be separated from the product when it is consumed or used. All components must be mentioned in the sorting information.



Brands have the option of adding the type of packaging in writing, in French, alongside the pictogram.

41% of consumers⁽¹⁾

state that text helps to explain, reassure and avoid misunderstandings, especially for packaging that is difficult to represent as an image (plastic ties, fillers, etc.).

The French text can be accompanied by a translation into another language (e.g. French/English) at the brand's discretion.

STEP 2 – Choosing the Sorting Info design

IV. Choosing how to represent the packaging waste stream

The stream can be represented in **one of two ways**

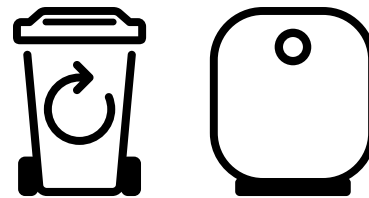
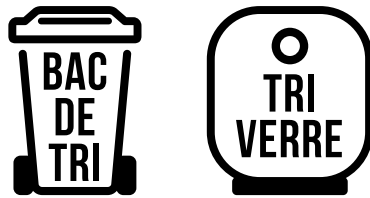

Text + pictogram

Pictogram only

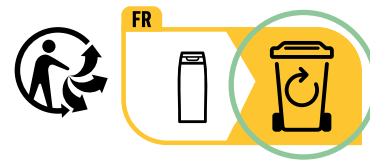
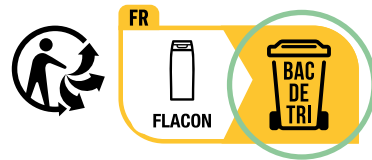

The drawings of the containers and the texts have been approved by the public authorities and may not be changed or customised.



For products marketed in French-speaking countries, Citeo recommends you use the pictogram and text combination. Considered clearer, it was the preferred option for **two-thirds of consumers** during preliminary tests⁽¹⁾.

STEP 2 – Choosing the Sorting Info design

V. Graphic standard elements to be used

1. Triman logo ⁽¹⁾

All the Sorting Info logo formats presented are designed in keeping with the label's graphic standards issued by Ademe (see p. 36).

2. Typeface

2a Country code

Flama Condensed Bold in capital letters

2b Packaging components

Helvetica Neue 77 Bold Condensed in capital letters

3. Exclusion zone

The Sorting Info's exclusion zone should be three times the thickness of the border line. ^(3a) This zone must always be clear of any element that may affect the legibility of the sorting info. ^(3b) If the background is busy, this zone is represented by a white box: a **legibility block**.



Make sure that letter stems are always at least 0.2 mm thick.

Make sure that the body text size is always at least **5 pt**, regardless of the layout and format.

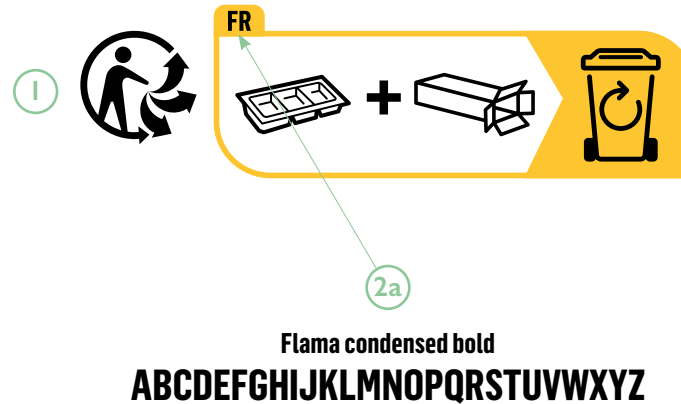

If you use the “text + pictograms” version.

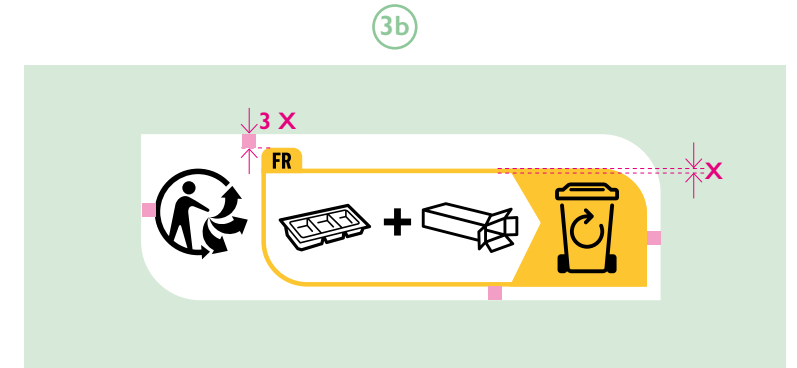
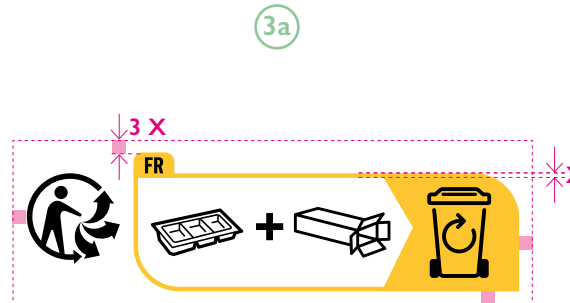
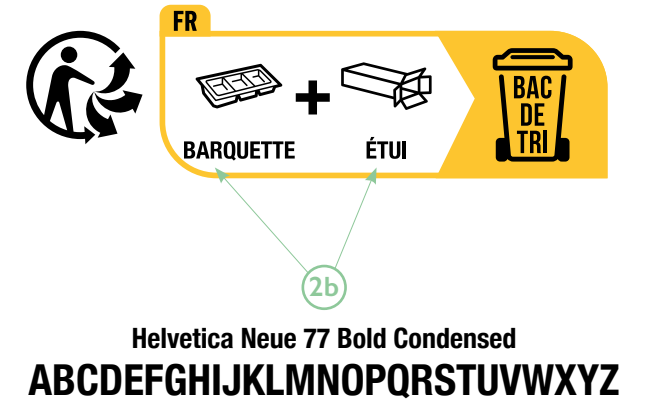

STEP 2 – Choosing the Sorting Info design

V. Graphic standard elements to be used

4. Packaging item pictograms

The pictograms available

A library of pictograms that depict most types of packaging currently in use (for food and non-food products) is available in your customer space.

Creating customised pictograms

You can design new packaging item outlines if necessary. In that case, you need to apply the following rules:

- the outline should preferably be a line drawing and only include two line thicknesses at most (a thicker line for the main contour and a thinner line for the internal details),
- the outline should be either (4a) a profile drawing or (4b) an isometric 3D drawing,
- the drawing must be able to fit into a 10 x 10 mm box, which in turn must be able to fit into a 13 x 13 mm box (default height of the standard Sorting Info block), with a clear space of 1.5 mm (see illustrations).

4a

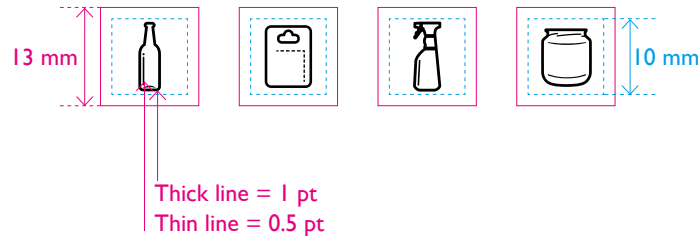
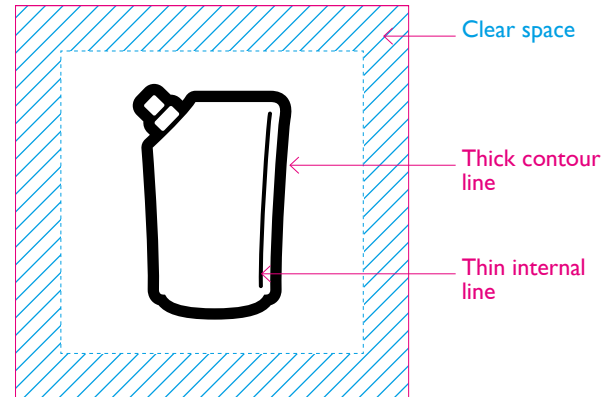
Examples of **profile** outlines

4b

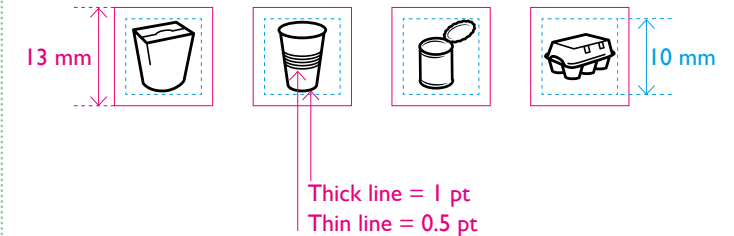
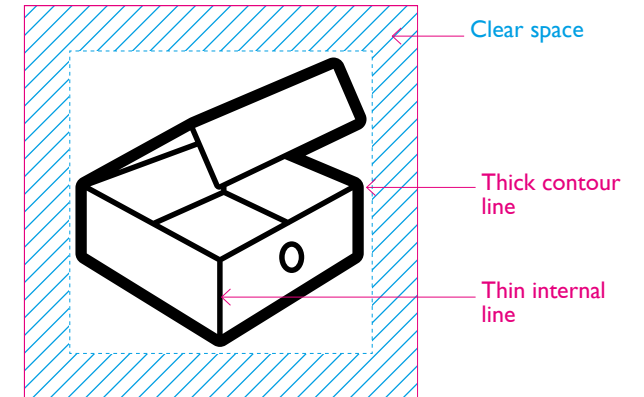
Examples of **isometric 3D** outlines

If you design new pictograms in compliance with the above instructions, they will not need to be approved by Citeo. Find the list of standard pictograms available per business sector, along with the corresponding graphics file, in your customer space (<https://clients-emballages.citeo.com>).

STEP 2 – Choosing the Sorting Info design

VI. Examples: cosmetic cream packaging

Cosmetic cream packaging

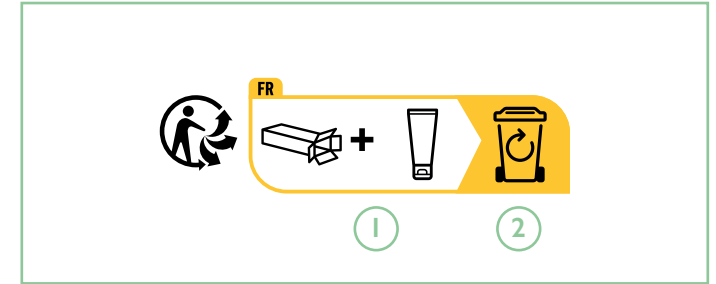
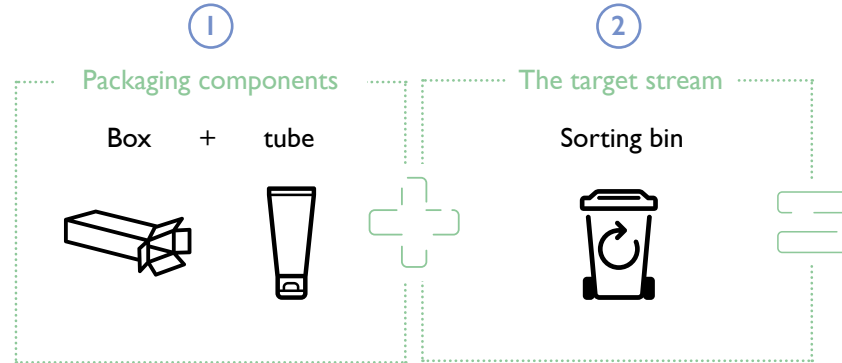

Other possibilities

Text + pictogram

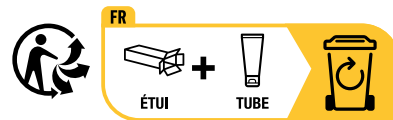

Text only

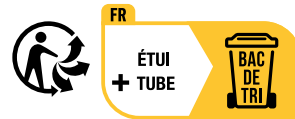

If packaging includes 3 components or more, you are allowed to use the standard phrase “packaging elements” for text-only versions.

All these versions are also available in monochrome.

STEP 2 – Choosing the Sorting Info design

VI. Example: beer bottle

Beer bottle

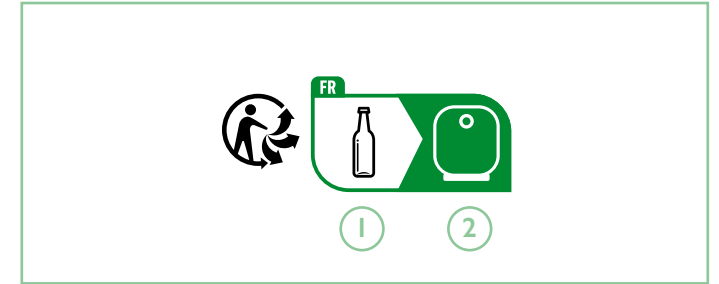
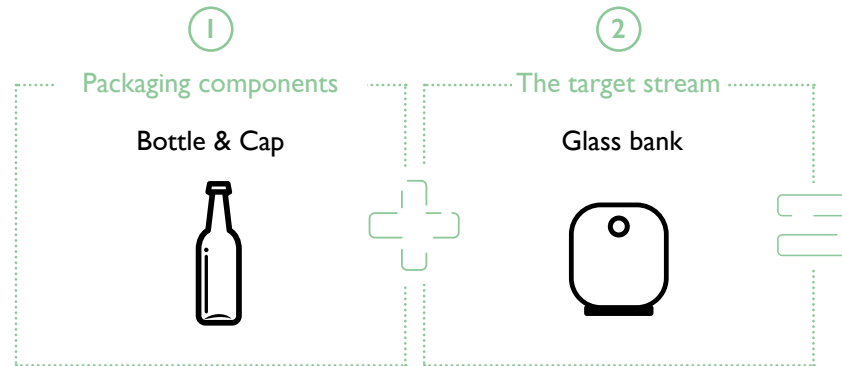

Other possibilities

Text + pictogram



Text only



Bottle tops, caps, lids:

which sorting rule applies and how can it be represented? See p. 46.



All these versions are also available in monochrome.

STEP 2 – Choosing the Sorting Info design

VI. Example: jar

Jar

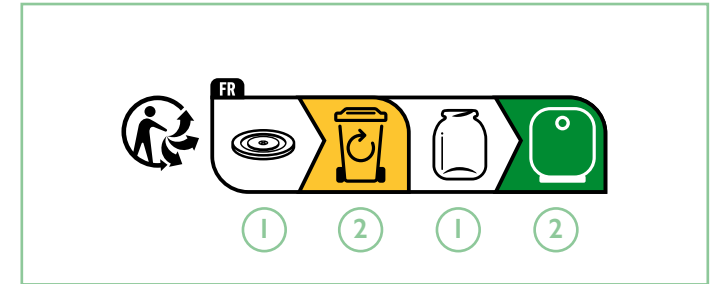
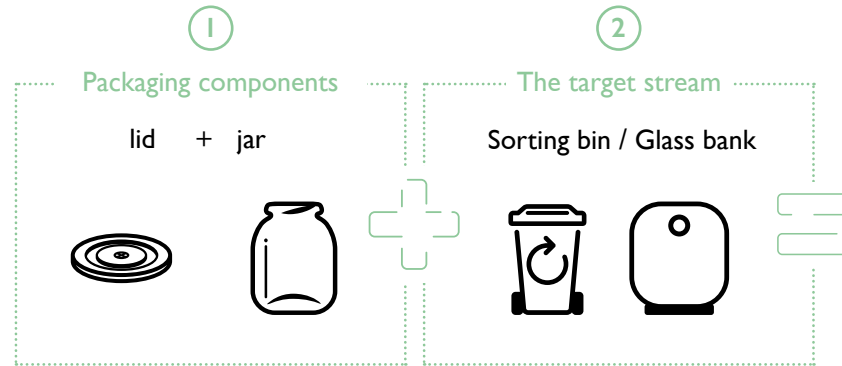

Other possibilities

Text + pictogram



Text only



Bottle tops, caps, lids:
which sorting rule applies and how can it be represented? See p. 46.

All these versions are also available in monochrome.

STEP 2 – Choosing the Sorting Info design

VII. Frequently asked questions (1/3)

Which guidelines apply if my packaging is made up of several components?

All the packaging components that can be separated during consumption must be shown, separated by a + sign.

Components can be represented by pictograms and text, by pictograms alone, or text alone. If packaging includes three components or more, you are permitted to use the standard phrase “packaging items”.

What is an element that can be “separated during consumption”?

This is an element that needs to be removed or separated from the main packaging to access the product (e.g. a cover or lid on a pot, a tube in a box, etc.). Packaging components that do not need to be removed for the product to be consumed (e.g. a pump or spray on a bottle, a sleeve on a bottle or pot, etc.) should not be mentioned in the Sorting Info, they are part of the main packaging element.

Why does this rule exist?

Asking consumers to systematically do more may prove counter-productive, especially with regard to consumers who only sort occasionally. This additional effort may also make consumers question how committed companies are to eco-design⁽¹⁾ principles.

What impact does it have on the evaluation of recyclability in the Citeo’s TREE tool?

Sorting Info does not have any direct impact on the evaluation of recyclability in TREE. The role of Sorting Info is to provide consumers with sorting instructions that encourage and help them to sort their waste. The role of TREE is to establish the recyclability of packaging based on data about actual sorting habits, which is collected at sorting centres. The method for calculating the recyclability indicator only takes packaging design into account, and not recommendations made to consumers.

Depending on the packaging, it may be advisable to **separate or not separate packaging components**, to make recycling easier. You also have the possibility of highlighting the need to separate or not separate certain packaging components, by adding **optional** extra information.

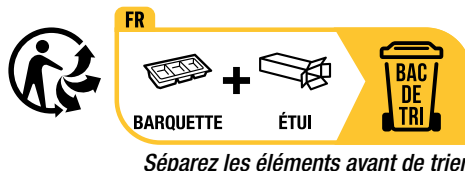

Optional separation information

Aside from the cases described above, and in some special cases (see p. 52), the text in the block may not be modified to provide your consumers with extra information.



Optional non-separation information

The wording of the extra information can vary according to the packaging components (e.g. “dispenser bottle” instead of “bottle” or “cap” instead of “bottle top”)⁽²⁾.

STEP 2 – Choosing the Sorting Info design

VII. Frequently asked questions (2/3)

Bottle tops, caps and lids: which sorting guideline applies and how can they be represented?

Bottle tops and caps

To ensure very small components are recovered and to prevent littering, bottle tops and caps should be left on all types of bottles and tubes. They now need to be represented on packaging (Example 1).

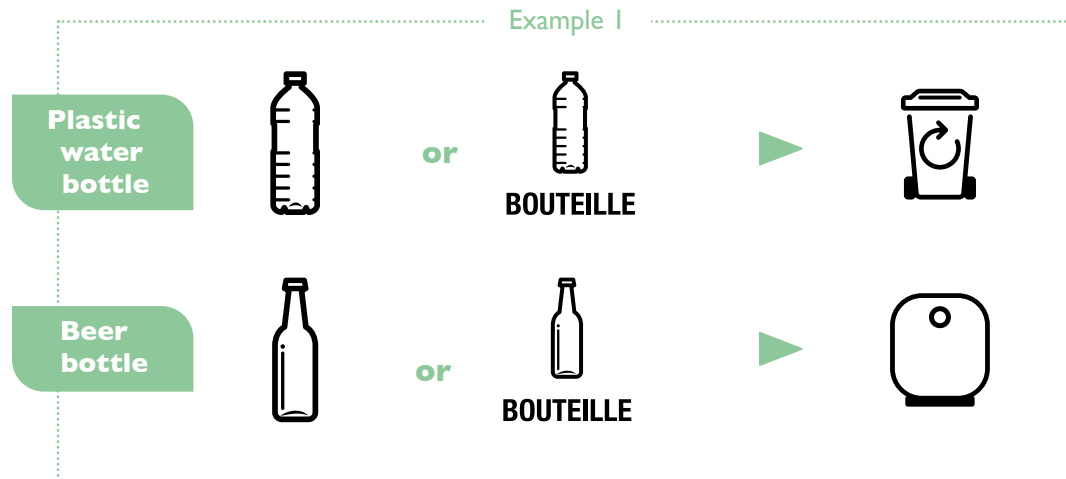

Flip top bottles - a special case

If you market bottles with flip tops attached to the bottle, you do not have to add the bottle top to the Sorting Info. You can just indicate “BOTTLE”. A pictogram of a bottle with a flip top attached is available in the Sorting Info kit’s pictogram library.

Lids

Larger than bottle tops and caps, lids can be identified at sorting centres. The separation instruction therefore varies **according to whether the lid is made of the same material as the main packaging or not**. If the material is the same, the lid can stay on the packaging (Example 2). If the material is different, the lid should be separated for sorting in the same place (Example 3), or in two different places (Example 4).

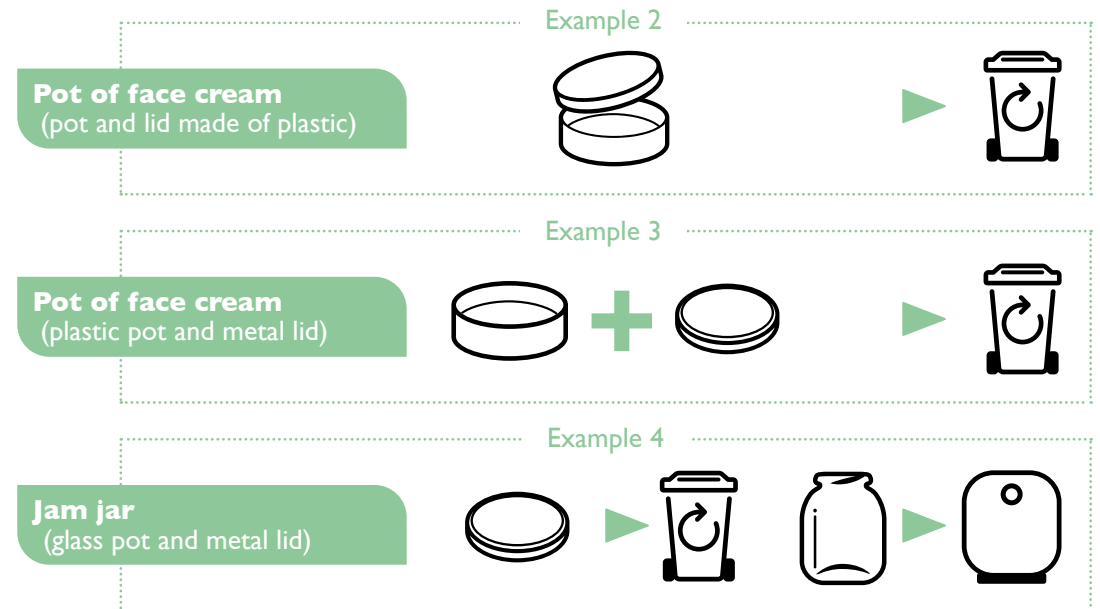

STEP 2 – Choosing the Sorting Info design

VII. Frequently asked questions (3/3)

Why use a circular arrow symbol rather than the Möbius loop?

To avoid using text, the “pictogram-only” version of the Sorting Info provides a pictogram of a sorting bin featuring a circular arrow. The circular arrow was felt to represent sorting better than the Möbius loop, which represents recyclability.

The goal was to avoid misleading the consumer on the final fate of their packaging. With the ESI, although most of the packaging waste discarded in the sorting bin can be recycled, some of it is still not recyclable. Now, under the new harmonised Sorting Info, the pictogram illustrating the target stream is the same for all packaging, regardless of recyclability. Using the **Möbius loop** on the sorting bin pictogram would be **misleading for consumers** as they would assume that all the packaging they sort is actually recycled. It was therefore felt that a circular arrow would better represent the purpose of the sorting bin. The symbol is understood by 7 out of 10 consumers.

“Sorting bin” and “Glass bank”



Which pictograms can I use for my packaging?

A non-exhaustive library of standard pictograms is available to help you create your Sorting Info. If you cannot find a pictogram that represents your packaging item, you can create your own outline drawing to ensure your consumers understand the information provided as thoroughly as possible (see p. 41). If you apply the design instructions, the new pictograms do not need to be approved by Citeo.



Reminder: the drawings of the containers and the texts have been approved by the public authorities and may not be changed or customised.

STEP 3 – Choosing the format

The Sorting Info format can vary according to the number of packaging components and any limits imposed by the packaging's shape or size.

We have a selection of **different layouts** to make it easier to incorporate Sorting Info onto your packaging.

Each one is available **in 2 versions**:

- A Standard:** This is the main version: It should be used by default if there is sufficient space on the packaging, and can be enlarged.
- B Compact:** This version should only be used if space is limited. **It cannot be reduced in size** as the Triman logo used here is already set at the minimum height of 6 mm authorised by Ademe.



Find all the Sorting Info marks available, according to the desired layout or format, in your customer space (<https://clients-emballages.citeo.com>)

A Standard version



Horizontal



Vertical



Grouped

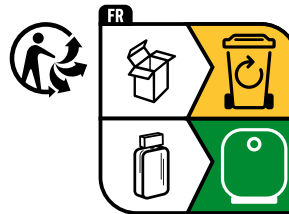

B Compact version



Please note: the Grouped version is only available for packaging destined for more than one recycling stream.

STEP 3 – Choosing the format

Horizontal layout

A Standard: this is your go-to version. The height of the legibility block is 18.3 mm. The elements (pictograms and/or text) should fit into a 13 mm square box, as shown in the illustration opposite. This ratio must be kept for enlargements. In exceptional cases, the 13 mm space can be widened to accommodate long words and avoid word breaks. All the elements then need to be optically centred in the white space in the Sorting Info block.

B Compact: this version should only be used if space is limited. **It should never be reduced in size.**

The height of the legibility block is 9.445 mm. The elements (pictograms and/or text) should fit into a 6.5 mm rectangular box, as shown in the illustration.

This ratio must be kept for enlargements. All the elements then need to be optically spaced and centred in the white space in the Sorting Info block.

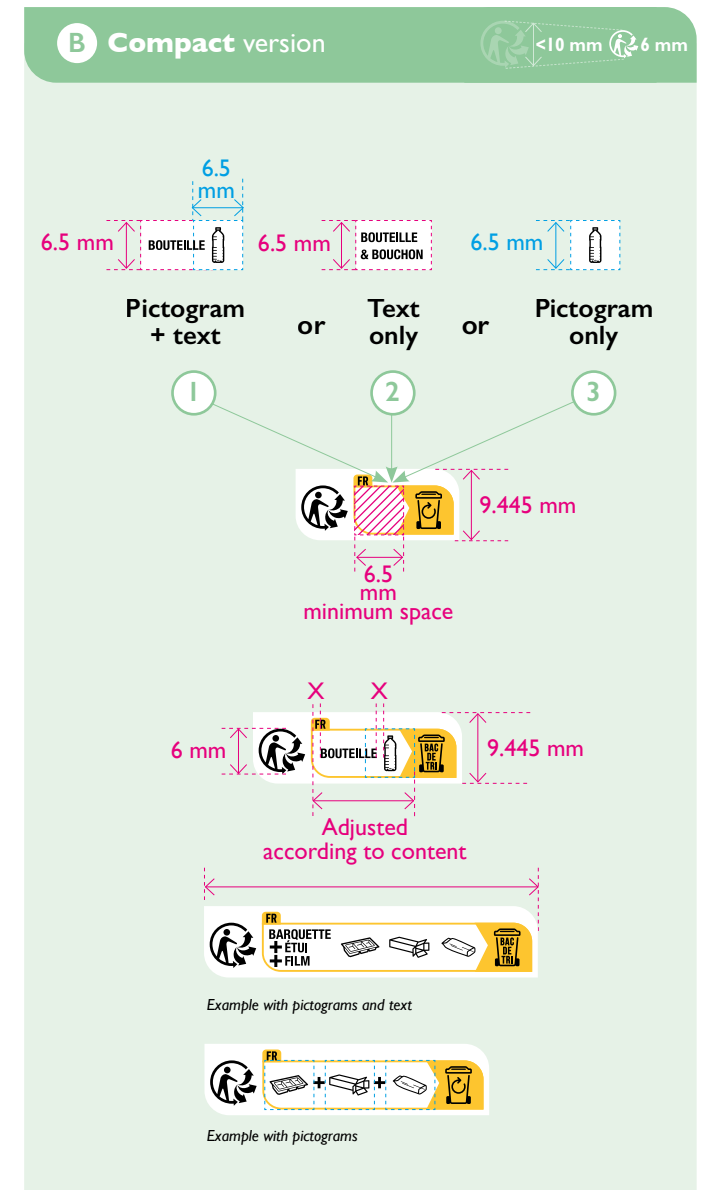
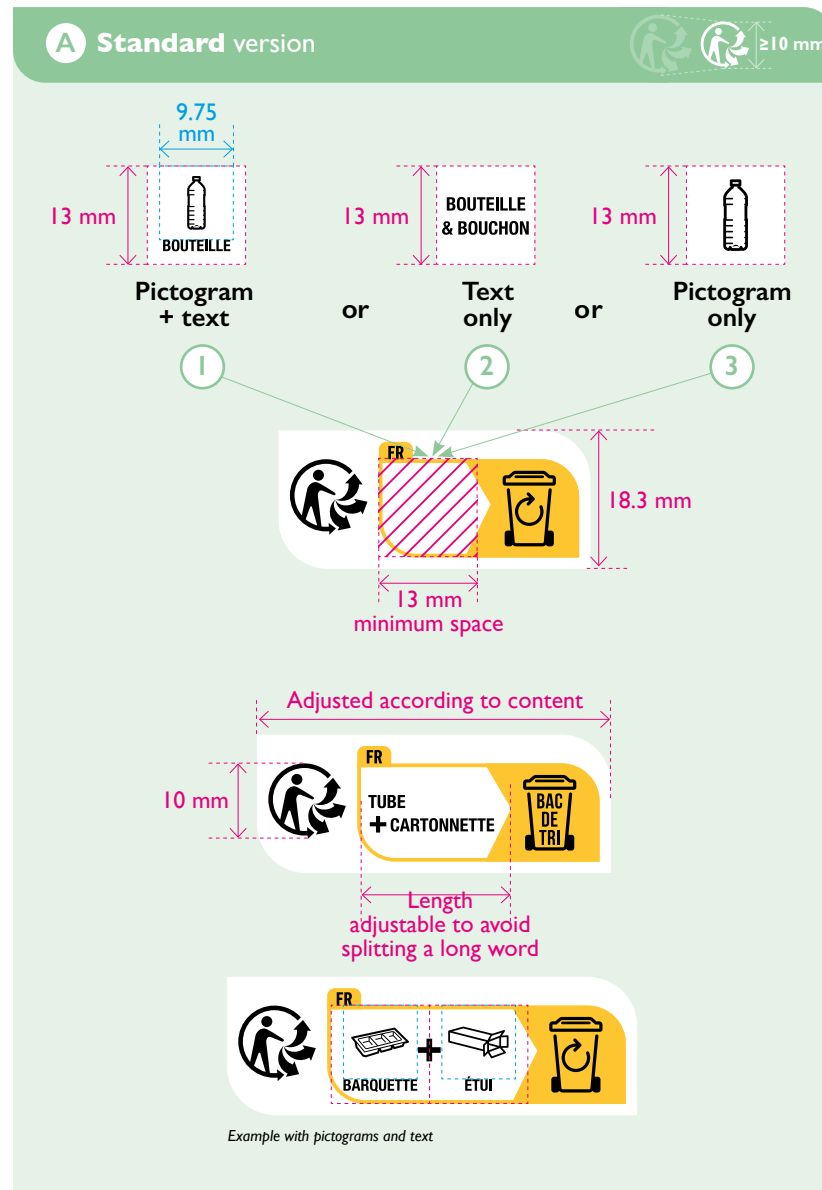

STEP 3 – Choosing the format

Vertical layout

A Standard: this is your go-to version. The width of the legibility block is 18.3 mm. The elements (pictograms and/or text) should fit into a 13 mm square box, as shown in the illustration opposite. This ratio must be kept for enlargements. All the elements then need to be optically centred in the white space in the Sorting Info block.

B Compact: this version should only be used if space is limited. **It should never be reduced in size.**

The width of the legibility block is 12.445 mm (or 9.455 mm with the pictogram only) and the elements (pictograms and/or text) should fit into a rectangular box, as shown in the illustration. This ratio must be kept for enlargements. All the elements then need to be optically centred in the white space in the Sorting Info block.

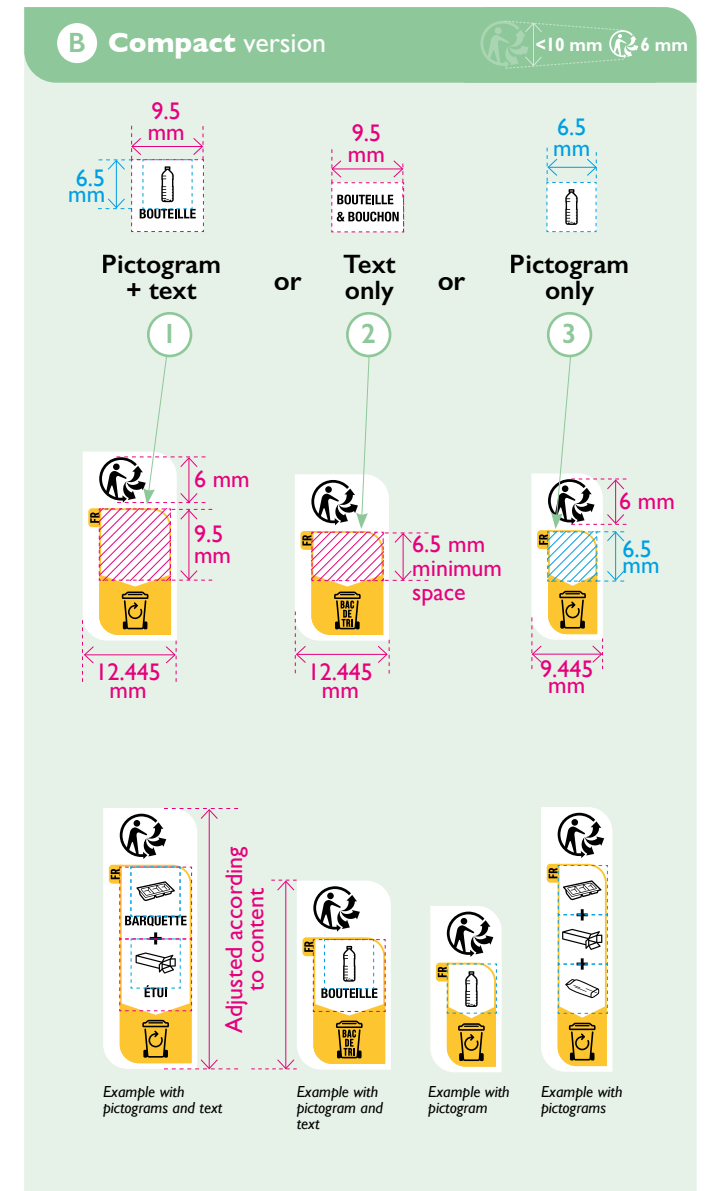
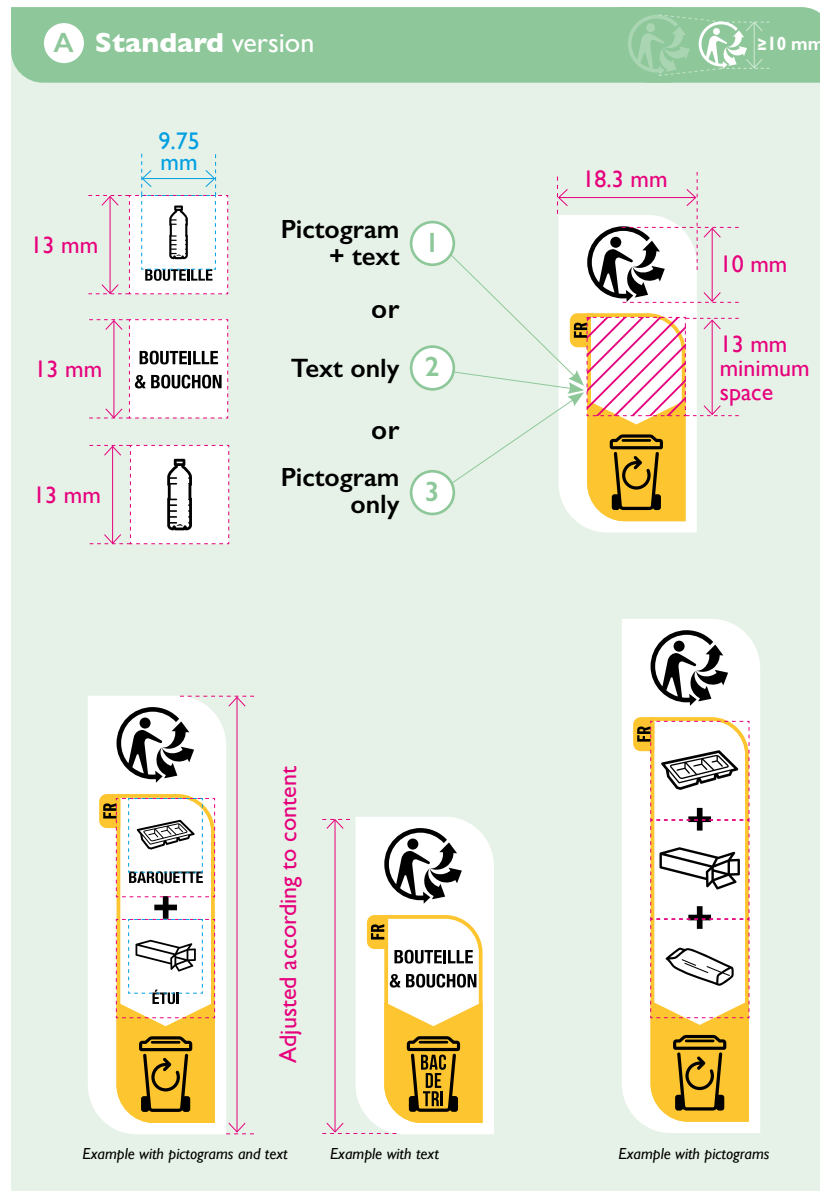

STEP 3 – Choosing the format

Grouped layout

A Standard: this is your go-to version. The height of the legibility block is 30.8 mm. The elements (pictograms and/or text) should fit into a 13 mm square box, as shown in the illustration opposite. This ratio must be kept for enlargements. In exceptional cases, the 13 mm space can be widened to accommodate long words and avoid word breaks. All the elements then need to be optically centred in the white space in the Sorting Info block.

B Compact: this version should only be used if space is limited. **It should never be reduced in size.** The height of the legibility block is 15.67 mm. The elements (pictograms and/or text) should fit into a 6.5 mm rectangular box, as shown in the illustration. This ratio must be kept for enlargements. All the elements then need to be optically spaced and centred in the white space in the Sorting Info block.

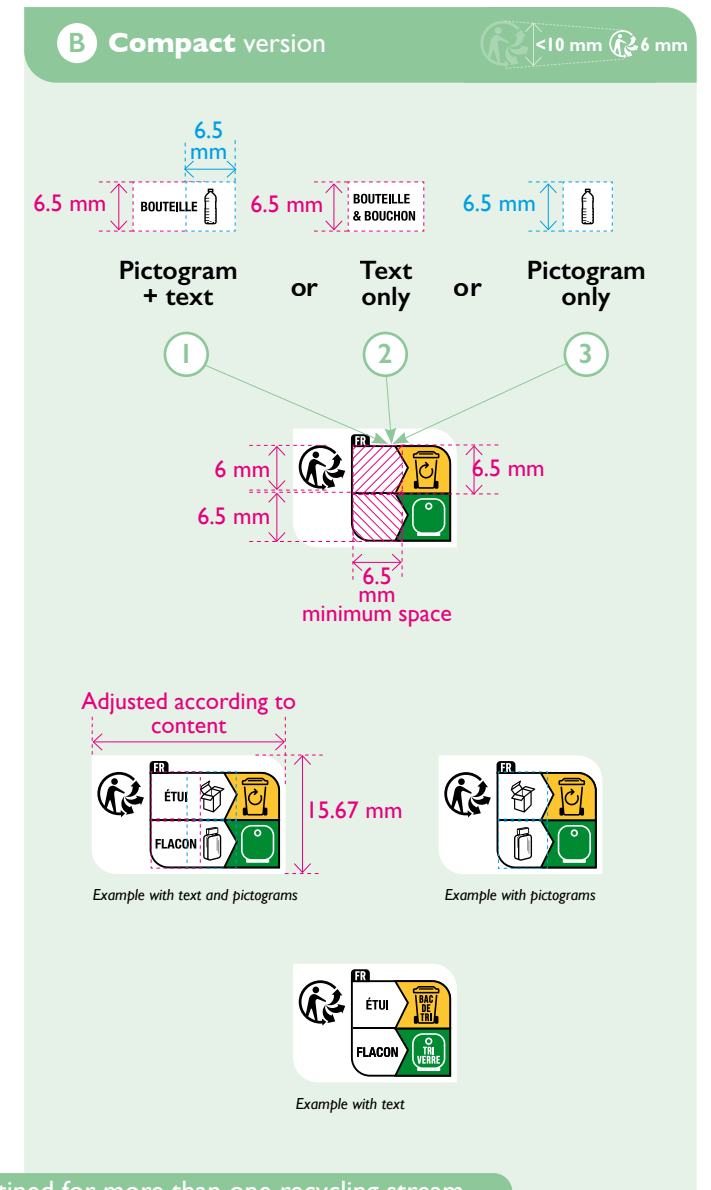
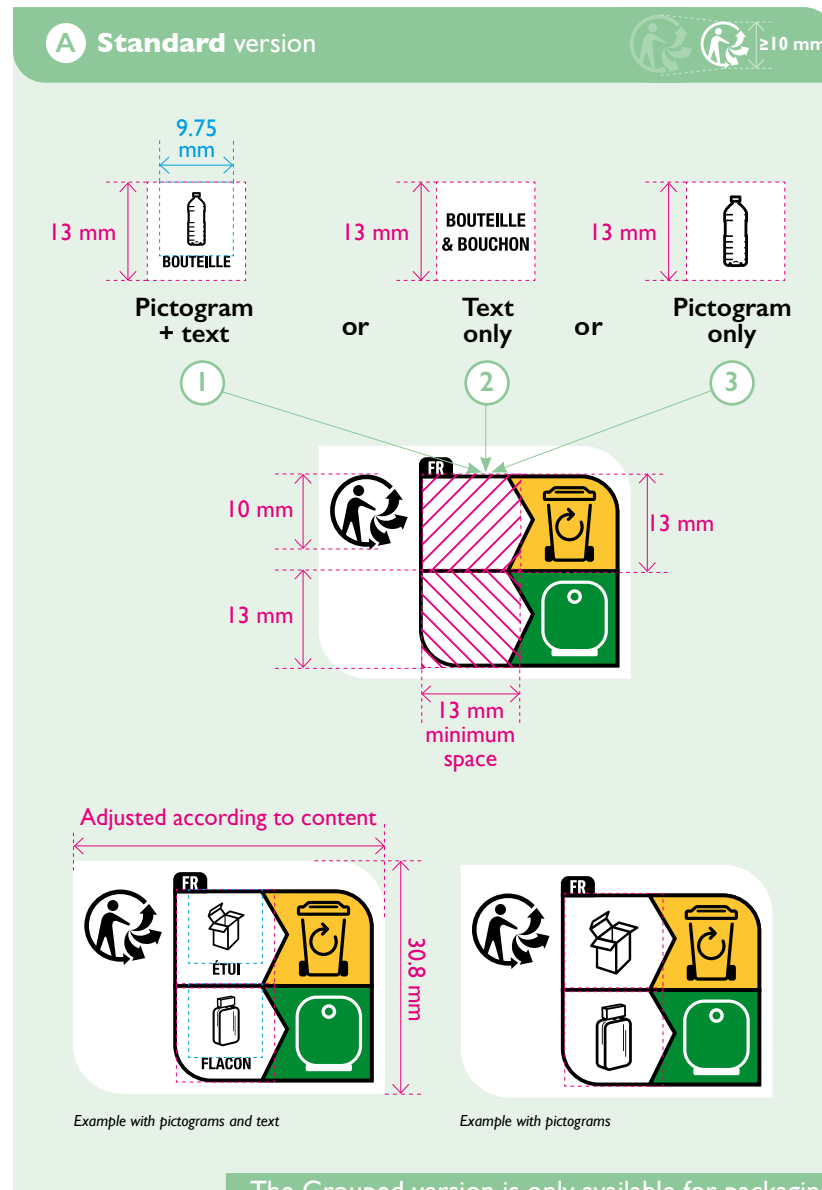

The Grouped version is only available for packaging destined for more than one recycling stream.



Special cases

Glass packaging for beverages

Article 17 of the French AGEC Law states that **glass packaging for beverages is exempt from the obligation** to add a sorting label. It is an exception. The Triman logo and Sorting Info are therefore added on glass beverage bottles on a voluntary basis.



Important: if your glass packaging for beverages carries a previous version of the Sorting Info label, you are free to replace it with the new label or remove it completely. **In both cases, you will need to change the design on your packaging as you will no longer be able to use the former Sorting Info label from 9 March 2023.**

Small packaging items

The implementing decree of Article 17 of the AGEC Law sets out specific provisions for two types of small packaging item:

- 1 **Packaging items less than 10 cm² in size** (largest side or total surface area) without accompanying documentation are exempt from sorting label and on-pack information obligations provided that corresponding information is available in electronic format.
- 2 **Packaging items between 10 and 20 cm² in size** (largest side or total surface area) without accompanying documentation must carry the Triman logo but are exempt from on-pack information obligations provided that such information is available in electronic format.

Small cylindrical or spherical packaging

For this type of packaging, a future decree will modify the above-mentioned 10 and 20 cm² surface areas to 20 and 40 cm² respectively. Please note, however, that this decree was not yet published in April 2022, when this document was updated. The new rules may not be adopted until the decree confirming this special case has been published officially.



79%⁽¹⁾

of consumers believe it is important to have sorting instructions on packaging.

64%⁽¹⁾

also believe the guideline would encourage them to choose one off-the-shelf product over another.

Special cases

The international version

If you plan to go a step further and prepare for future regulatory developments in some of the countries to which you export your products, you can choose to add the sorting rules for the countries concerned thanks to the “international” version of the Sorting Info label. The above situation may arise if you export your products to countries which are considering making sorting information mandatory on packaging, but without imposing a specific display format for it.



Important: if you wish to display sorting instructions for both France and other countries with the same sorting rules, you can simply add extra tabs, which must always come after the “FR” tab.

Additionally, given that the colour coding for streams is not always the same elsewhere as in France, the Sorting Info must be designed in black and white to avoid misleading foreign consumers.

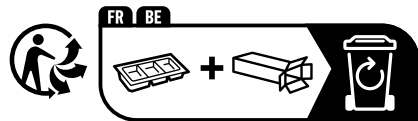

Please note: the sorting instructions shown on this page are not real-life examples.

Examples

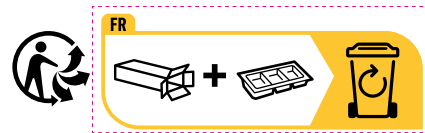

The first block shows the sorting instructions for France. The tab labelled “FR” is mandatory.

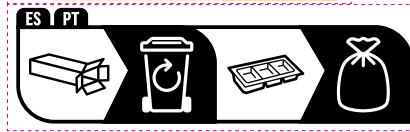

The second block is used to show the sorting instructions for countries where different sorting rules apply. For colour versions, this block is always printed in black and white.

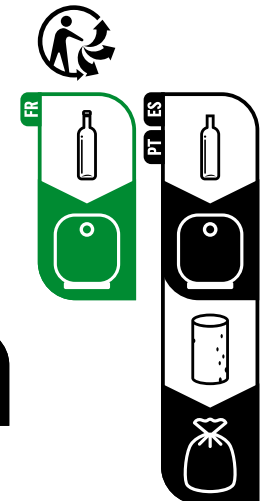

ANY QUESTIONS?

Please send us a message via the
“Contact us” tab
in your customer space or
get in touch with your usual contact person.



50, boulevard Haussmann
75009 Paris, France

+33 (0)1 81 69 06 00
www.citeo.com
clients.emballages.citeo.com

If you print this document, don't forget to sort it.

